

Yealink

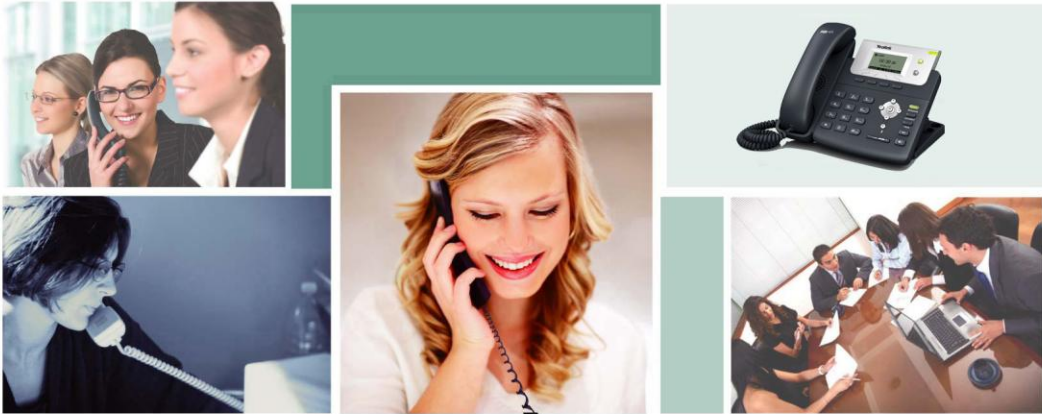

HD 

SIP-T21
SIP-T21P

Enterprise IP Phone

User Guide

Version 72.1

Dec. 2013

Copyright

Copyright © 2013 YEALINK NETWORK TECHNOLOGY CO., LTD

Copyright © 2013 Yealink Network Technology CO., LTD. All rights reserved. No parts of this publication may be reproduced or transmitted in any form or by any means, electronic or mechanical, photocopying, recording, or otherwise, for any purpose, without the express written permission of Yealink Network Technology CO., LTD. Under the law, reproducing includes translating into another language or format.

When this publication is made available on media, Yealink Network Technology CO., LTD. gives its consent to downloading and printing copies of the content provided in this file only for private use but not for redistribution. No parts of this publication may be subject to alteration, modification or commercial use. Yealink Network Technology CO., LTD. will not be liable for any damages arising from use of an illegally modified or altered publication.

Warranty

THE SPECIFICATIONS AND INFORMATION REGARDING THE PRODUCTS IN THIS GUIDE ARE SUBJECT TO CHANGE WITHOUT NOTICE. ALL STATEMENTS, INFORMATION, AND RECOMMENDATIONS IN THIS GUIDE ARE BELIEVED TO BE ACCURATE AND PRESENTED WITHOUT WARRANTY OF ANY KIND, EXPRESS OR IMPLIED. USERS MUST TAKE FULL RESPONSIBILITY FOR THEIR APPLICATION OF PRODUCTS.

YEALINK NETWORK TECHNOLOGY CO., LTD. MAKES NO WARRANTY OF ANY KIND WITH REGARD TO THIS GUIDE, INCLUDING, BUT NOT LIMITED TO, THE IMPLIED WARRANTIES OF MERCHANTABILITY AND FITNESS FOR A PARTICULAR PURPOSE. Yealink Network Technology CO., LTD. shall not be liable for errors contained herein nor for incidental or consequential damages in connection with the furnishing, performance, or use of this guide.

Declaration of Conformity



Hereby, Yealink Network Technology CO., LTD. declares that this phone is in conformity with the essential requirements and other relevant provisions of the CE, FCC.

CE Mark Warning

This device is marked with the CE mark in compliance with EC Directives 2006/95/EC and 2004/108/EC.

Part 15 FCC Rules

This device is compliant with Part 15 of the FCC Rules. Operation is subject to the following two conditions:

1. This device may not cause harmful interference, and
2. This device must accept any interference received, including interference that may cause undesired operation.

Class B Digital Device or Peripheral

Note: This device is tested and complies with the limits for a Class B digital device, pursuant to Part 15 of the FCC Rules. These limits are designed to provide reasonable protection against harmful interference in a residential installation. This equipment generates, uses, and can radiate radio frequency energy and, if not installed and used in accordance with the instructions, may cause harmful interference to radio communications. However, there is no guarantee that interference will not occur in a particular installation. If this equipment does cause harmful interference to radio or television reception, which can be determined by turning the equipment off and on, the user is encouraged to try to correct the interference by one or more of the following measures:

1. Reorient or relocate the receiving antenna.
2. Increase the separation between the equipment and receiver.
3. Connect the equipment into an outlet on a circuit different from that to which the receiver is connected.
4. Consult the dealer or an experienced radio/TV technician for help.

WEEE Warning



To avoid the potential effects on the environment and human health as a result of the presence of hazardous substances in electrical and electronic equipment, end users of electrical and electronic equipment should understand the meaning of the crossed-out wheeled bin symbol. Do not dispose of WEEE as unsorted municipal waste and have to collect such WEEE separately.

Customer Feedback

We are striving to improve our documentation quality and we appreciate your feedback. Email your opinions and comments to DocsFeedback@yealink.com.

GNU GPL INFORMATION

Yealink SIP-T21P/SIP-T21 firmware contains third-party software under the GNU General Public License (GPL). Yealink uses software under the specific terms of the GPL. Please refer to the GPL for the exact terms and conditions of the license.

The original GPL license, source code of components licensed under GPL and used in Yealink products can be downloaded online:

<http://www.yealink.com/GPLOpenSource.aspx?BaseInfoCatId=293&NewsCatId=293&CatId=293>.

About This Guide

Thank you for choosing the SIP-T21P/SIP-T21 IP phone, exquisitely designed to provide business telephony features, such as Call Hold, Call Transfer, Busy Lamp Field, Multicast Paging and Conference over an IP network. The difference between the SIP-T21P and SIP-T21 IP phone is that the former supports PoE, while the latter does not.

This guide provides everything you need to quickly use your new phone. First, verify with your system administrator that the IP network is ready for phone configuration. Also be sure to read the Packaging Contents and Regulatory Notices sections in this guide before you set up and use the SIP-T21P/SIP-T21 IP phone.

If this is your first time using the SIP-T21P/SIP-T21 IP phone, we recommend that you first refer to the *Quick Installation Guide* and *Quick Reference Guide*, available online: http://www.yealink.com/SupportDownloadfiles_detail.aspx?CatId=333&flag=142.

Note

Shared Line, Busy Lamp Field List, Network Directory and Network Call Log features are hidden for IP phones in neutral firmware version, which are designed for BroadWorks environment. Please contact your system administrator for more information.

In This Guide

Topics provided in this guide include:

- Chapter 1 [Overview](#)
- Chapter 2 [Getting Started](#)
- Chapter 3 [Customizing Your Phone](#)
- Chapter 4 [Basic Call Features](#)
- Chapter 5 [Advanced Phone Features](#)

Summary of Changes

This section describes the changes to this guide for each release and guide version.

Changes for Release 72, Guide Version 72.1

Major updates have occurred to the following sections:

- [LED Instructions](#) on page 4

- [Anonymous Call](#) on page 93

Changes for Release 71, Guide Version 71.91

Documentations of the SIP-T21 IP phone have also been added.

Changes for Release 71, Guide Version 71.90

Major updates have occurred to the following sections:

- [LED Instructions](#) on page 4
- [Anonymous Call](#) on page 93
- [Troubleshooting](#) on page 117

Table of Contents

About This Guide	v
In This Guide	v
Summary of Changes	v
Changes for Release 72, Guide Version 72.1	v
Changes for Release 71, Guide Version 71.91	vi
Changes for Release 71, Guide Version 71.90	vi
Table of Contents	vii
Overview	1
Hardware Component Instructions	1
Icon Instructions	3
LED Instructions	4
User Interfaces	5
Phone User Interface	5
Web User Interface	5
Documentations	8
Getting Started	9
Packaging Contents	9
Phone Installation	11
Phone Initialization	13
Phone Status	13
Basic Network Settings	14
Registration	16
Idle Screen	16
Customizing Your Phone	17
General Settings	17
Contrast	17
Language	18
Time & Date	19
Administrator Password	20
Key as Send	21
Keypad Lock	21
Audio Settings	24

Volume	24
Ring Tones	25
Contact Management	27
Directory	27
Local Directory	28
Blacklist	38
Remote Phone Book	40
Call History Management	42
System Customizations	44
Logo Customization	44
Headset Use	45
DSS Keys	46
Account Management	54
Dial Plan	55
Emergency Number	60
Live Dialpad	61
Hotline	62
Basic Call Features	63
Placing Calls	63
Answering Calls	65
Ending Calls	66
Redialing Numbers	67
Recent Call In Dialing	67
Auto Answer	68
Auto Redial	69
Call Completion	70
Call Return	71
Call Mute	71
Call Hold/Resume	72
Do Not Disturb (DND)	73
Call Forward	76
Call Transfer	82
Call Waiting	84
Conference	84
Local Conference	85
Network Conference	85
Call Park	87
Call Pickup	88
Anonymous Call	93
Anonymous Call Rejection	94
Advanced Phone Features	95

Busy Lamp Field (BLF)	95
Call Recording	97
Hot Desking	99
Intercom	101
Outgoing Intercom Calls	101
Incoming Intercom Calls	101
Multicast Paging	103
Sending RTP Stream	103
Receiving RTP Stream	105
Music on Hold	106
Automatic Call Distribution (ACD)	107
Messages	109
Short Message Service (SMS)	109
Voice Mail	111
Message Waiting Indicator (MWI)	112
Troubleshooting	117
Regulatory Notices	127
Service Agreements	127
Limitations of Liability	127
Safety Instructions	127
Appendix A - Time Zones	129
Index	131

Overview

This chapter provides the overview of the SIP-T21P/SIP-T21 IP phone. Topics include:

- [Hardware Component Instructions](#)
- [Icon Instructions](#)
- [LED Instructions](#)
- [User Interfaces](#)
- [Documentations](#)



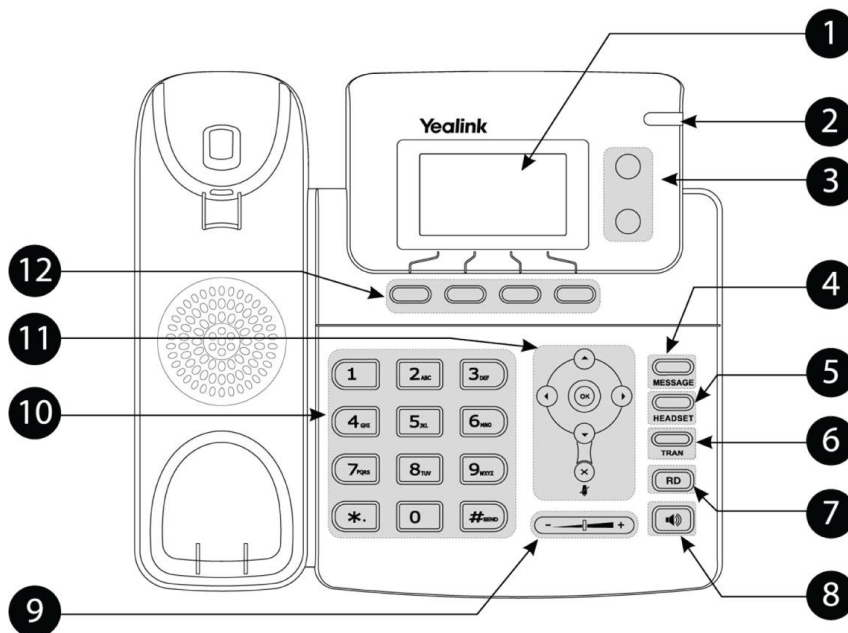

If you require additional information or assistance with your new phone, contact your system administrator.

Hardware Component Instructions

The main hardware components of the SIP-T21P/SIP-T21 IP phone are the LCD screen and the keypad.































Hardware component instructions of the SIP-T21P/SIP-T21 IP phone are:

	Item	Description
①	LCD Screen	Shows information about calls, messages, soft keys, time, date and other relevant data: <ul style="list-style-type: none"> • Call information — caller ID, call duration • Icons (for example, ) • Missed call text or second incoming caller information • Prompt text (for example, "Saving config file!") • Time and date
②	Power Indicator LED	Indicates phone power status and phone status.
③	Line Keys	Use these keys to activate up to two accounts and assign various features.
④	MESSAGE Key	Indicates and accesses voice mails.
⑤	HEADSET Key	Toggles the headset mode.
⑥	TRAN Key	Transfers a call to another party.
⑦	RD Key	Redials a previously dialed number.
⑧	Speakerphone Key	Toggles the hands-free speakerphone mode.
⑨	Volume Key	Adjusts the volume of the handset, headset, speaker, and ringer.
⑩	Keypad	Provides the digits, letters and special characters in context-sensitive applications.
⑪		Scroll through the displayed information.
		Confirms actions or answers incoming calls.
		Cancels actions, rejects incoming calls, mutes or un-mutes calls.
⑫	Soft Keys	Label automatically to identify their context-sensitive features.

Icon Instructions

Icons appearing on the LCD screen are described in the following table:

Icon	Description
	Network is unavailable
	Registered successfully
	Register failed
	Registering
	Hands-free speakerphone mode
	Handset mode
	Headset mode
	Multi-lingual lowercase letters input mode
	Multi-lingual uppercase letters input mode
	Alphanumeric input mode
	Numeric input mode
	Multi-lingual uppercase and lowercase letters input mode
	Voice Mail
	Text Message
	Auto Answer
	Do Not Disturb
	Call Forwarded/Forwarded Calls
	Call Hold
	Call Mute
	Ringer volume is 0

Icon	Description
	Keypad Lock
	Received Calls
	Placed Calls
	Missed Calls
	Recording box is full
	A call cannot be recorded
	Recording starts successfully
	Recording cannot be started
	Recording cannot be stopped

LED Instructions

Power Indicator LED

LED Status	Description
Solid green	The phone is initializing. The phone is busy. The phone is idle. The call is placed on hold or is held. The phone receives a text message or voice mail.
Fast flashing green (300ms)	The phone is ringing. The call is mute.
Off	The phone is powered off.

Line key LED

LED Status	Description
Solid green	The line is in conversation. The line is seized.
Fast flashing green	The line receives an incoming call.
Slow flashing green	The call is placed on hold.
Off	The line is inactive.

Line key LED (configured as a BLF key)

LED Status	Description
Solid green	The monitored user is idle.
Fast flashing green (200ms)	The monitored user receives an incoming call.
Slow flashing green (500ms)	The monitored user is dialing. The monitored user is talking. The monitored user's conversation is placed on hold.
Slow flashing green (1s)	The call is parked against the monitored user's phone number.
Off	The monitored user does not exist.

Note

The above introduces the default LED status. The statuses of the power indicator LED and BLF key are configurable via web user interface. For more information, refer to *Yealink_SIP-T2xP_and_SIP-T19P_IP_Phone_Family_Administrator_Guide*.

User Interfaces

Two ways to customize configurations of your SIP-T21P/SIP-T21 IP phone:

- The user interface on the IP phone.
- The user interface in a web browser on your PC.

The hardware components keypad and LCD screen constitute the phone user interface, which allows the user to execute all call operation tasks and basic configuration changes directly on the phone. In addition, you can use the web user interface to access all configuration settings. In many cases, either the phone user interface and/or the web user interface interchangeably. However, in some cases, it is only possible to use one or the other interface to operate the phone and change settings.

Phone User Interface

You can customize your phone by pressing the Menu soft key to access the phone user interface. The Advanced Settings option is only accessible to the administrator, and the default administrator password is "admin" (case-sensitive). For more information on customizing your phone with the available options from the phone user interface, refer to [Customizing Your Phone](#) on page 17.

Web User Interface

In addition to the phone user interface, you can also customize your phone via web user interface. In order to access the web user interface, you need to know the IP address of your new phone. To obtain the IP address, press the OK key on the phone. Enter the IP

address (e.g., <http://192.168.0.10> or 192.168.0.10) in the address bar of web browser on your PC. The default administrator user name and password are both “admin” (case-sensitive).

The options you can use to customize the IP phone via phone user interface and/or via web user interface are listed in the following table:

Options	Phone User Interface	Web User Interface
Status		
--IP Address		
--MAC		
--Firmware	√	√
--Network		
--Phone		
--Accounts		
Basic Phone Settings		
--Contrast	√	√
--Language	√	√
--Time & Date	√	√
--Administrator Password	√	√
--Key as Send	√	√
--Keypad Lock	√	√
-- Volume	√	
--Ring Tones	√	√
--Contact Management		
--Directory		√
--Local Directory	√	√
--Blacklist	√	√
--Remote Phone Book		√
--Call History Management	√	√
--Logo Customization		√
--Headset Prior		√
--DSS Keys	√	√
--Account Registration	√	√
--Dial Plan		√
--Emergency Number		√
--Live Dialpad		√
--Hotline	√	√
Basic Call Features		
--Recent Call In Dialing		
--Auto Answer	√	√
--Auto Redial	√	
--Call Completion	√	
--Call Return	√	

Options	Phone User Interface	Web User Interface
--DND	√	
--Call Forward	√	
--Call Transfer	√	
--Call Waiting	√	
--Conference		
--Call Park	√	
--Call Pickup	√	
--Anonymous Call	√	
--Anonymous Call Rejection	√	
Advanced Phone Features		
--BLF	√	
--Call Recording	√	
--Hot Desking	√	
--Intercom	√	√
--Multicast Paging		
--Music on Hold		
--ACD	√	
--Messages	√	
SIP Account		
--User Options		
--Register Status	√	
--Activation	√	
--Label	√	
--Display Name	√	
--Register Name	√	
--User Name	√	
--Password	√	√
--SIP Server1/2	√	
--Server Option		
--Server Port		
--Outbound Status	√	
--Outbound Proxy	√	
--NAT Traversal		
--STUN Status	√	
--STUN Server	√	

Note

The table above lists most of the feature options. Please refer to the relevant sections for more information.

Documentations

The following table shows documentations available for the SIPT21P/SIP-T21 IP phone.

Name	Contents	Where found	Language
Quick Installation Guide	Basic setup of the phone	In the package	English
Quick Reference Guide	Basic call features and phone customizations	In the package	English
User Guide	Phone/Web user interface settings Basic call features and advanced phone features	CD attached in the package	English

Note

You can also download the latest documentations online:

http://www.yealink.com/SupportDownloadfiles_detail.aspx?CatId=333&flag=142.

Getting Started

This chapter provides basic installation instructions and information for obtaining the best performance with the SIP-T21P/SIP-T21 IP phone. Topics include:

- [Packaging Contents](#)
- [Phone Installation](#)
- [Phone Initialization](#)
- [Phone Status](#)
- [Basic Network Settings](#)
- [Registration](#)
- [Idle Screen](#)

If you require additional information or assistance with your new phone, contact your system administrator.

Packaging Contents

The following components are included in your SIP-T21P/SIP-T21 IP phone package:

- **SIP-T21P/SIP-T21 IP Phone**

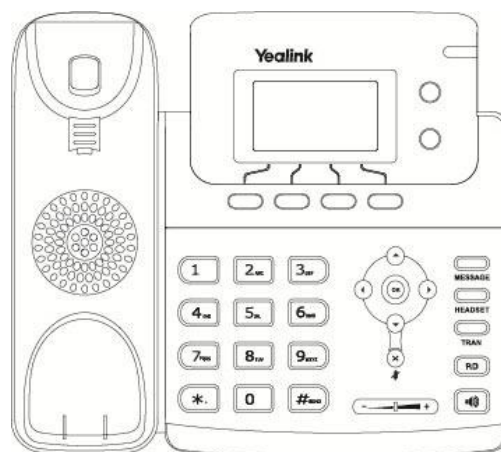

- **Phone Stand**

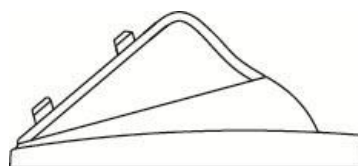

- **Power Adapter**

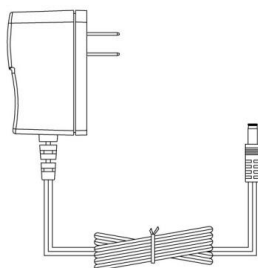

- **Handset & Handset Cord**

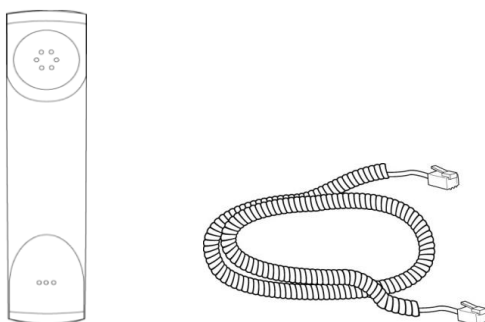

- **Ethernet Cable**

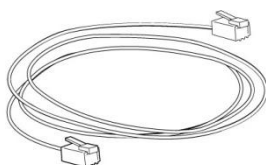

- **Quick Installation Guide & Quick Reference Guide**

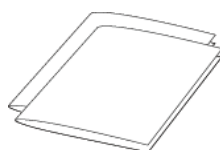

- **CD-ROM**



Check the list before installation. If you find anything missing, contact your system administrator.

Phone Installation

If your phone is already installed, proceed to [Phone Initialization](#) on page 13.

This section introduces how to install the phone:

- 1) Attach the stand
- 2) Connect the handset and optional headset
- 3) Connect the network and power

1) Attach the stand

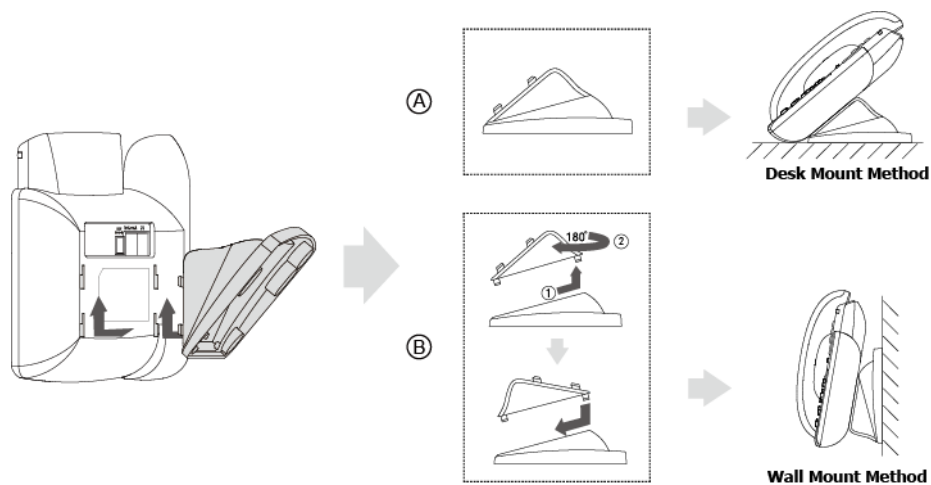

2) Connect the handset and optional headset

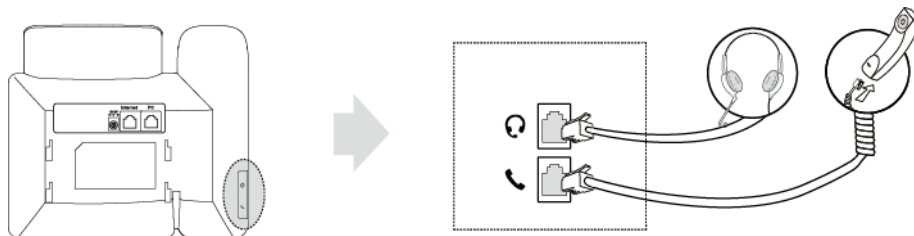

Note

A headset is not included in the packaging contents. Contact your system administrator for more information.

3) Connect the network and power

You have two options for power and network connections. Your system administrator will advise you which one to use.

- AC power
- Power over Ethernet (PoE)

AC Power

To connect the AC power:

1. Connect the DC plug on the power adapter to the DC5V port on the phone and connect the other end of the power adapter into an electrical power outlet.
2. Connect the included or a standard Ethernet cable between the Internet port on the phone and the one on the wall or switch/hub device port.

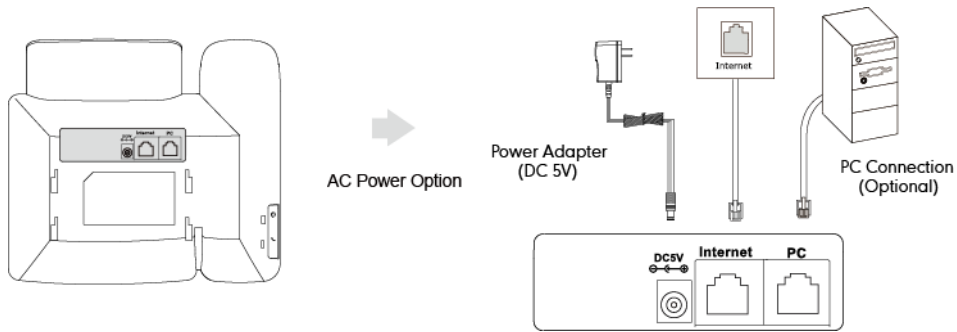

Power over Ethernet

With the included or a regular Ethernet cable, the SIP-T21P IP phone can be powered from a PoE-compliant switch or hub. PoE is not applicable to the SIPT21 IP phone.

To connect the PoE for the SIP-T21P IP phone:

1. Connect the Ethernet cable between the Internet port on the phone and an available port on the in-line power switch/hub.

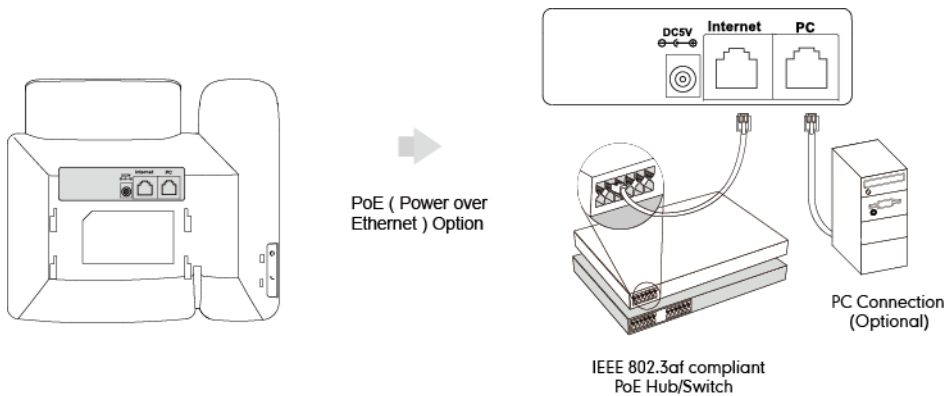

Note

If in-line power switch/hub is provided, you don't need to connect the phone to the power adapter. Make sure the switch/hub is PoE-compliant.

The phone can also share the network with another network device such as a PC (personal computer). It is an optional connection.

Important! Do not unplug or remove power to the phone while it is updating firmware and configurations.

Phone Initialization

After your phone is powered on, the system boots up and performs the following steps:

Automatic Phone Initialization

The phone finishes the initialization by loading the saved configuration. The LCD screen displays “Initializing...please wait” during this process.

DHCP (Dynamic Host Configuration Protocol)

The phone attempts to contact a DHCP server in your network to obtain valid IPv4 and IPv6 network settings (e.g., IP address, subnet mask, default gateway address and DNS address) by default.

Note If your network does not use DHCP, proceed to [Basic Network Settings](#) on page 14.

Phone Status



You can view phone status via phone user interface or web user interface.

Available information of phone status includes:

- Network status (e.g., IPv4 status, IPv6 status, IP mode and MAC address).
- Phone status (e.g., device model, hardware version, firmware version, product ID, MAC address and device certificate status).
- Account status (e.g., the register status of SIP accounts).

Note You can view device certificate status via phone user interface only.

To view the phone status via phone user interface:

1. Press , or press **Menu->Status**.
2. Press  or  to scroll through the list and view the specific information.

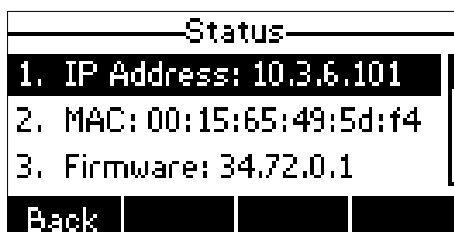

To view the phone status via web user interface:

1. Open the web browser of your computer.
2. Enter the IP address in the browser's address bar, and then press **Enter**.

3. Enter the user name (admin) and password (admin) in the login page.

4. Click **Confirm** to login.

The phone status is displayed on the first page of the web user interface.

Category	Item	Value
Version	Firmware Version	34.72.0.1
	Hardware Version	34.0.0.0.0.0.0
Network	Internet Port	IPv4
IPv4	WAN Port Type	DHCP
	WAN IP Address	10.3.6.101
	Subnet Mask	255.255.255.0
	Gateway	10.3.6.254
	Primary DNS	192.168.1.167
	Secondary DNS	192.168.1.166
Network Common	MAC Address	001565495df4
	Link Status	Connected
	Device Type	Bridge
AccountStatus	Account1	Disabled
	Account2	Disabled

Basic Network Settings

If your phone cannot contact a DHCP server for any reason, you need to configure network settings manually. The IP phone can support either or both IPv4 and IPv6 addresses.

To configure the IP address mode via phone user interface:

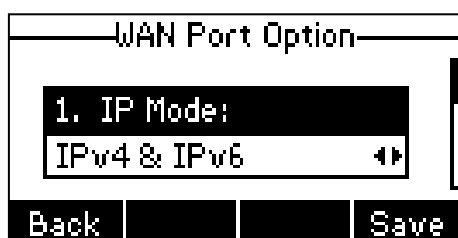

1. Press **Menu->Settings->Advanced Settings** (password: admin) ->**Network->WAN Port**.

- Press  or  to select **IPv4**, **IPv6** or **IPv4 & IPv6** from the **IP Mode** field.



- Press the **Save** soft key to accept the change or the **Back** soft key to cancel.

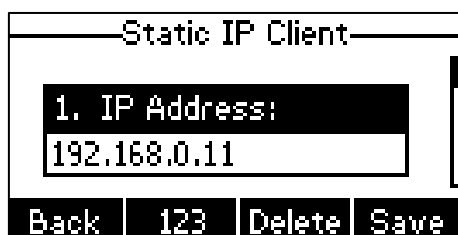

To configure a static IPv4 address via phone user interface:

- Press **Menu->Settings->Advanced Settings** (password: admin) ->**Network->WAN Port**.
- Press  to select **IPv4** and press the **Enter** soft key.
- Press  to select **Static IP Client** and press the **Enter** soft key.
- Enter the desired values in the **IP Address**, **Subnet Mask**, **Default Gateway**, **Pri.DNS** and **Sec.DNS** fields respectively.



- Press the **Save** soft key to accept the change or the **Back** soft key to cancel.

To configure a static IPv6 address via phone user interface:

- Press **Menu->Settings->Advanced Settings** (password: admin) ->**Network->WAN Port**.
- Press  to select **IPv6** and press the **Enter** soft key.
- Press  to select **Static IPv6 Client** and press the **Enter** soft key.
- Enter the desired values in the **IPv6**, **IPv6 Prefix**, **IPv6 Gateway**, **IPv6 Pri.DNS** and **IPv6 Sec.DNS** fields respectively.

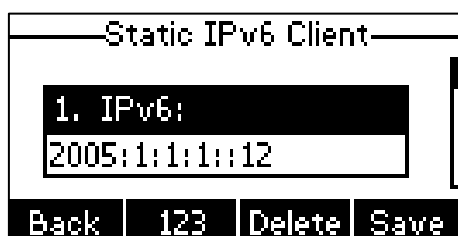

- Press the **Save** soft key to accept the change or the **Back** soft key to cancel.

If you are using an xDSL modem for IPv4 network connection, you can connect your phone to the Internet via PPPoE mode. Set the WAN port as a PPPoE port. The PPPoE port

will perform a PPP negotiation to obtain the IP address. Contact your system administrator for the PPPoE user name and password.

To configure PPPoE via phone user interface:

1. Press **Menu->Settings->Advanced Settings** (password: admin) ->**Network->WAN Port**.
2. Press to select **IPv4** and press the **Enter** soft key.
3. Press to select **PPPoE IP Client** and press the **Enter** soft key.



4. Enter the user name and password in the corresponding fields.
5. Press the **Save** soft key to accept the change or the **Back** soft key to cancel.

Note

Wrong network settings may result in inaccessibility of your phone and may also have an impact on your network performance. For more information on these parameters, contact your system administrator.

Registration

Generally, your phone will be deployed with multiple other phones. In this case, your system administrator will configure the phone parameters beforehand, so that after you start up your phone, the phone will be registered and ready for use. If your phone is not registered, you may have to register it. For more information on how to register your phone, refer to [Account Management](#) on page 54.

Idle Screen

If the phone has successfully started up, the idle screen will be shown as below:

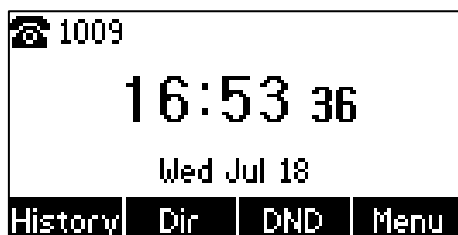

The idle screen shows the label of current account, time and date, and four soft keys.

Customizing Your Phone

You can customize your SIP-T21P/SIPT21 IP phone by personally configuring certain settings, for example, contrast, language and time & date. You can add contacts to the phone's local directory manually or from call history. You can also personalize different ring tones for different callers.

This chapter provides basic operating instructions for customizing your phone. Topics include:

- [General Settings](#)
- [Audio Settings](#)
- [Contact Management](#)
- [Call History Management](#)
- [System Customizations](#)



If you require additional information or assistance with your new phone, contact your system administrator.

General Settings

Contrast

You can configure the contrast of the LCD screen to a comfortable level.

To configure the contrast via phone user interface:

1. Press **Menu->Settings->Basic Settings->Contrast**.
2. Press  or , or the **Switch** soft key to increase or decrease the intensity of contrast.

The default contrast level is 6.

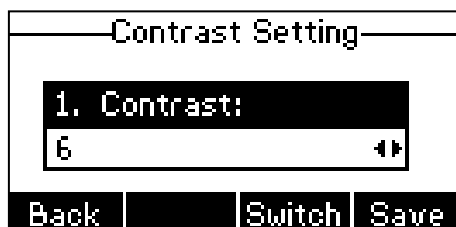

3. Press the **Save** soft key to accept the change or the **Back** soft key to cancel.

Contrast is configurable via web user interface at the path **Settings->Preference**.



Language

The default language of the phone user interface is English. The phone will detect and use the same language as which of your web browser for the web user interface. If the language of your web browser is not supported by the phone, the web user interface will use English. You can change the language for the phone user interface and the web user interface respectively.

Note

Not all of the supported languages are available for selection. The available languages depend on the language packs currently loaded to the IP phone. Please contact your system administrator for more information on the available languages of your new phone.

To change the language for the phone user interface:

1. Press **Menu->Settings->Basic Settings->Language**.
2. Press  or  to select the desired language.



3. Press the **Save** soft key to accept the change.

Text displayed on the LCD screen will change to the selected language.

To change the language for the web user interface:

1. Click on **Settings->Preference**.
2. Select the desired language from the pull-down list of **Language**.

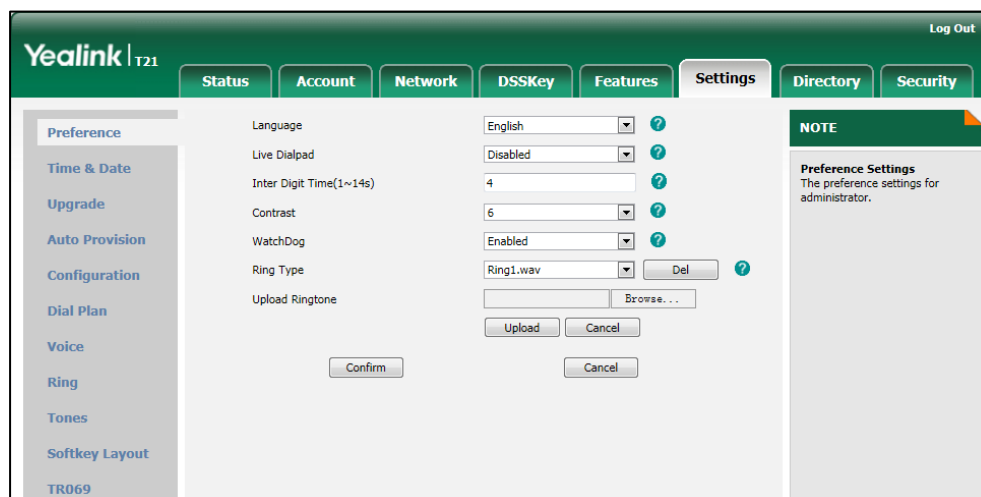

3. Click **Confirm** to accept the change.

Text displayed on the web user interface will change to the selected language.

Time & Date

The time and date are displayed on the LCD screen when the phone is idle. If the phone cannot obtain the time and date from the Simple Network Time Protocol (SNTP) server, you need to configure the time and date manually. For more information on the SNTP server, contact your system administrator.

To configure the SNTP settings via phone user interface:

1. Press **Menu->Settings->Basic Settings->Time & Date->SNTP Settings**.



2. Press **◀** or **▶**, or the **Switch** soft key to select the time zone that applies to your area from the **Time Zone** field.
The default time zone is "+8 China(Beijing)".
3. Enter the domain names or IP addresses in the **NTP Server 1** and **NTP Server 2** fields respectively.
4. Press **◀** or **▶**, or the **Switch** soft key to select the desired value from the **DST** field.
5. Press the **Save** soft key to accept the change or the **Back** soft key to cancel.

Note

Please refer to [Appendix A - Time Zones](#) for the list of available time zones on the IP phone.

To configure the time and date manually via phone user interface:

1. Press **Menu->Settings->Basic Settings->Time & Date->Manual Settings**.
2. Enter the specific date in the **Date** field.
3. Enter the specific time in the **Time** field.

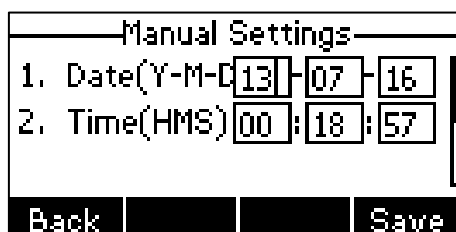

4. Press the **Save** soft key to accept the change.

The date and time displayed on the LCD screen will change accordingly.

To configure the time and date format via phone user interface:

1. Press **Menu->Settings->Basic Settings->Time & Date->Time & Date Format**.

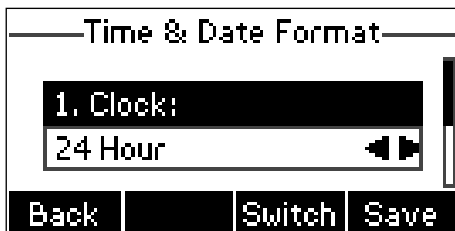

2. Press **◀** or **▶**, or the **Switch** soft key to select the desired time format from the **Clock** field.
3. Press **◀** or **▶**, or the **Switch** soft key to select the desired date format from the **Date Format** field.
4. Press the **Save** soft key to accept the change or the **Back** soft key to cancel.

There are 7 available date formats. For example, for the date format “WWW DD MMM”, “WWW” represents the abbreviation of the week, “DD” represents the two-digit day, and “MMM” represents the first three letters of the month.

The date formats you need to know:

Date Format	Example(2013-1-16)
WWW MMM DD	Wed Jan 16
DD-MMM-YY	16-Jan-13
YYYY-MM-DD	2013-01-16
DD/MM/YYYY	16/01/2013
MM/DD/YY	01/16/13
DD MMM YYYY	16 Jan 2013
WWW DD MMM	Wed 16 Jan

Time and date is configurable via web user interface at the path **Settings->Time & Date**.

Administrator Password

The Advanced Settings option is only accessible to the administrator. The default administrator password is “admin”. For security reasons, you should change the default administrator password as soon as possible.

To change the administrator password via phone user interface:

1. Press **Menu->Settings->Advanced Settings** (password: admin) ->**Set Password**.

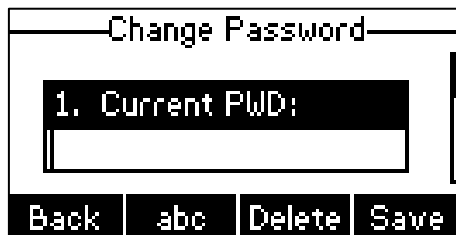



2. Enter the current password in the **Current PWD** field.
3. Enter the new password in the **New PWD** field.
4. Enter the new password again in the **Confirm PWD** field.
5. Press the **Save** soft key to accept the change or the **Back** soft key to cancel.

Administrator password is configurable via web user interface at the path **Security->Password**.

Key as Send

You can set the “#” or “*” to perform as a send key while dialing.

To configure key as send via phone user interface:

1. Press **Menu->Features->Key as Send**.
2. Press  or , or the **Switch** soft key to select # or * from the **Key as Send** field, or select **Disable** to disable this feature.

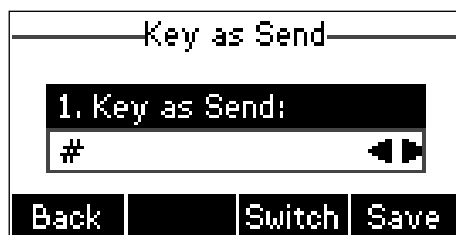

3. Press the **Save** soft key to accept the change or the **Back** soft key to cancel.

Key as send is configurable via web user interface at the path **Features->General Information**.

Keypad Lock

You can lock the keypad of your phone temporarily when you are not using it. This feature helps you to protect your phone from unauthorized use.

Keypad lock consists of the following:

Menu Key: The Menu soft key is locked. You cannot access the menu of the

phone until unlocked.



Function Keys: The function keys are locked. You cannot use the MESSAGE, RD, TRAN, OK, X, navigation keys, soft keys and line keys until unlocked.

All Keys: All keys are locked except the Volume key. You are only allowed to dial emergency numbers, reject incoming calls by pressing the X key, answer incoming calls by lifting the handset, pressing the Speakerphone key, the HEADSET key or the OK key, mute an active call by pressing the X key, place an active call on hold by pressing the Hold soft key, resume the held call by pressing the Resume soft key, and end the call by hanging up the handset or pressing the Speakerphone key.



Note

The emergency number setting, if desired, must be made before lock activation. For more information, refer to [Emergency Number](#) on page 60.

To activate the keypad lock via phone user interface:

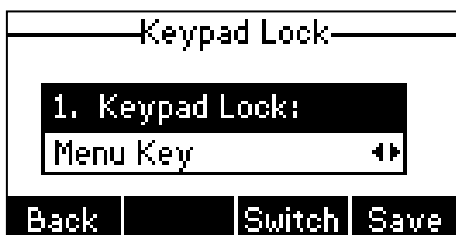
1. Press **Menu->Settings->Advanced Settings** (password: admin) ->**Keypad Lock**.
2. Press  or  , or the **Switch** soft key to select the desired type from the **Keypad Lock** field.



3. Press the **Save** soft key to accept the change.
4. Long press  to lock the keypad immediately when the phone is idle. The LCD screen prompts "Keypad locked!" and displays the icon .

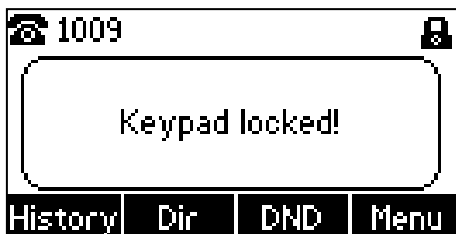

You can configure the interval (in seconds) to automatically lock the keypad instead of long pressing .

To configure the interval of automatic keypad lock via web user interface:

1. Click on **Features->Phone Lock**.

2. Enter the desired interval in the **Phone Lock Time Out (0~3600s)** field.

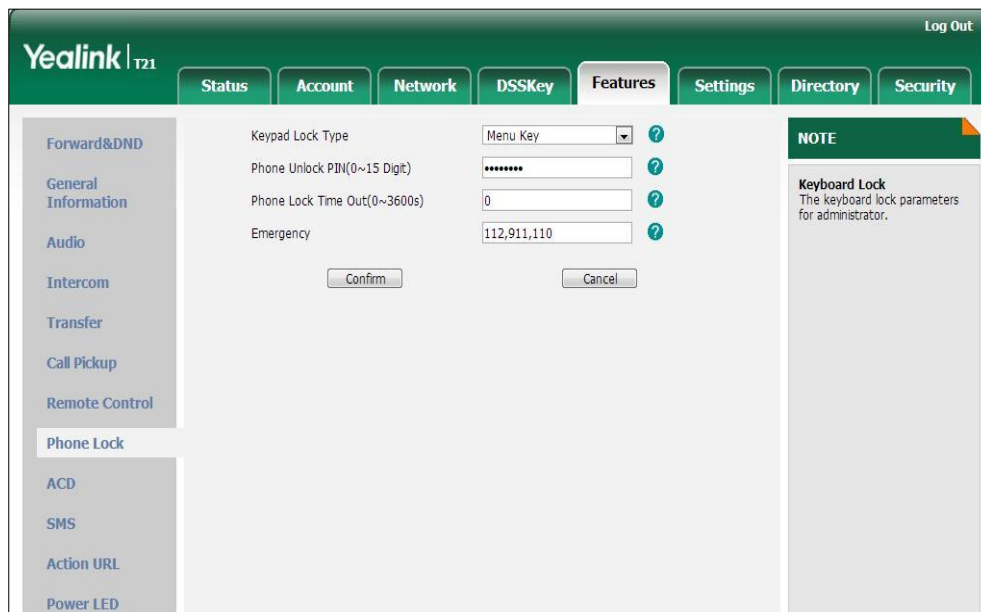

3. Click **Confirm** to accept the change.

Note The default interval is 0 second, that is, you need to long press  to lock the keypad. The interval of automatic keypad lock is configurable via web user interface only.

To unlock the keypad, you must know the keypad unlock PIN of the phone. The default keypad unlock PIN is "123".

To change the keypad unlock PIN via phone user interface:

1. Press **Menu->Settings->Basic Settings->Phone Unlock PIN**.

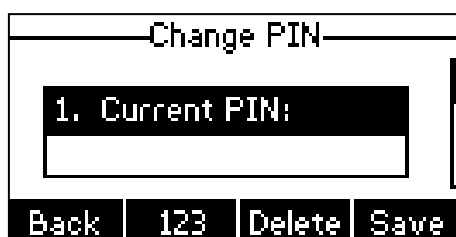

2. Enter the current PIN in the **Current PIN** field.
3. Enter the new PIN in the **New PIN** field.
4. Enter the new PIN again in the **Confirm PIN** field.
5. Press the **Save** soft key to accept the change or the **Back** soft key to cancel.

Note The unlock PIN length must be within 15 digits.

To unlock the keypad via phone user interface:

1. Press any locked key, the LCD screen prompts "Please Enter PIN".



2. Enter the PIN in the **PIN** field.
3. Press the **Cfm** soft key to unlock the keypad.



The  icon disappears from the LCD screen.

You can long press  or wait for a period of time (if configured) to lock the keypad again.

Note

You can also unlock the keypad by administrator password. When you enter the administrator password to unlock the keypad, the phone will turn to the **Reset Phone PIN** screen.

To deactivate the keypad lock via phone user interface:

1. Press **Menu->Settings->Advanced Settings** (password: admin) ->**Keypad Lock**.
2. Press  or , or the **Switch** soft key to select **Disable** from **Keypad Lock** field.



3. Press the **Save** soft key to accept the change.

Keypad lock is configurable via web user interface at the path **Features->Phone Lock**.

Audio Settings

Volume

You can press the Volume key to adjust the ringer volume when the phone is idle. You can also press the Volume key to adjust the receiver volume of currently engaged audio devices (handset, speakerphone or headset) when the phone is in use.

To adjust the volume when the phone is idle:

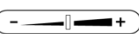
1. Press  to adjust the ringer volume.



Note

If the ringer volume is adjusted to minimum, the  icon will appear on the LCD screen.

To adjust the volume when the phone is during a call:



1. Press  to adjust the volume of currently engaged audio device (handset, speakerphone or headset).



Ring Tones

Ring tones are used to indicate incoming calls. You can select different ring tones to distinguish different accounts registered on your phone, or to distinguish your phone from your neighbor's.

To select a ring tone for the phone via phone user interface:

1. Press **Menu->Settings->Basic Settings->Ring Tones**.
2. Press  or  to select the desired ring tone.

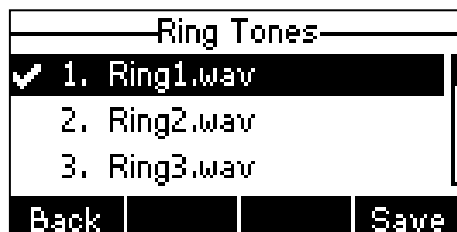

3. Press the **Save** soft key to accept the change or the **Back** soft key to cancel.

To select a ring tone for the account via web user interface:

1. Click on **Account**.
2. Select the desired account from the pull-down list of **Account**.
3. Click on **Basic**.
4. Select the desired ring tone from the pull-down list of **Ring Type**.

If **Common** is selected, this account will use the ring tone selected for the phone.
Refer to the above instruction.

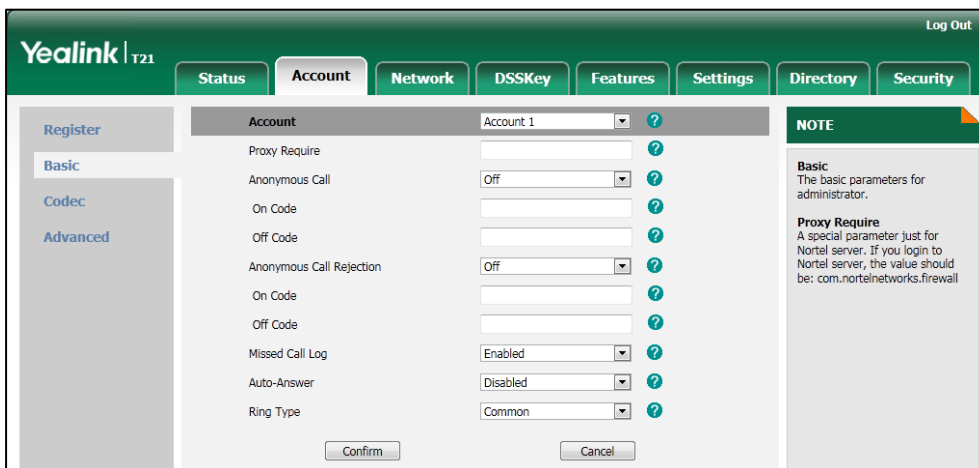

5. Click **Confirm** to accept the change.

Note A ring tone for the account is configurable via web user interface only.

To upload a custom ring tone for your phone via web user interface:

1. Click on **Settings->Preference**.
2. Click **Browse** to locate a ring tone (file format must be *.wav) file from your local system.

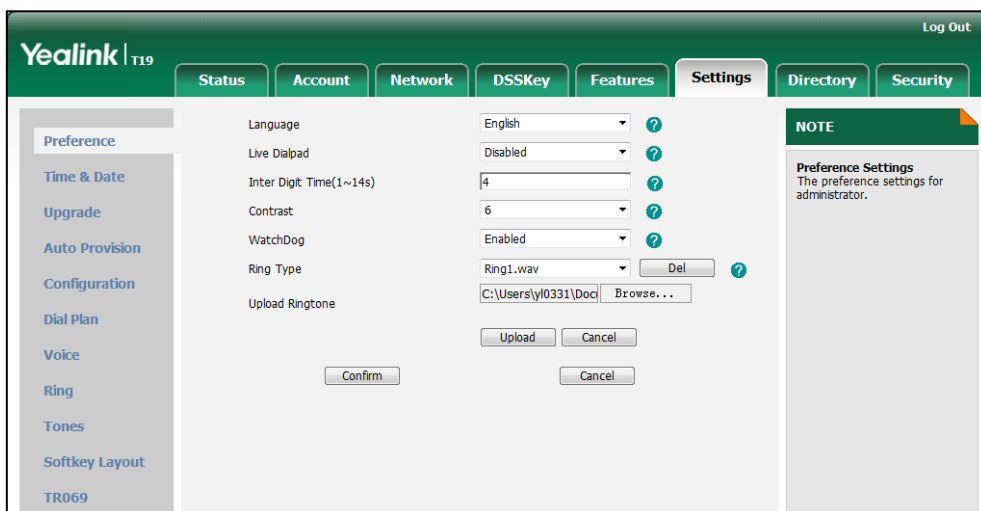

3. Click **Upload** to upload the file.

Note

The ring tone for an incoming call on the phone may be different. For example, when the phone receives an incoming call from a contact stored in the local directory, it will play the ring tone assigned to the contact in the contact directory (refer to [Adding Contacts](#)). If no ring tone is assigned to the contact, the phone will play the ring tone assigned to the associated group (refer to [Adding Groups](#)). Otherwise, the phone will play the ring tone assigned to the account. If no ring tone is assigned to the account, the phone will play the ring tone assigned for the phone.

All custom ring tone files must be within 100KB. Uploading custom ring tones for your phone is configurable via web user interface only.

Contact Management

This section provides the operating instructions for managing contacts. Topics include:

- [Directory](#)
- [Local Directory](#)
- [Blacklist](#)
- [Remote Phone Book](#)

Directory



Directory provides easy access to frequently used lists. The lists may contain Local Directory, History, Remote Phone Book and LDAP.

To configure the directory via web user interface:

1. Click on **Directory->Setting**.
2. In the **Directory** block, select the desired list from the **Disabled** column and then click .

The selected list appears in the **Enabled** column.

3. Repeat step 2 to add more lists to the **Enabled** column.
4. To remove a list from the **Enabled** column, select the desired list and then click .

- To adjust the display order of enabled lists, select the desired list and then click  or .

The LCD screen displays the list(s) in the adjusted order.

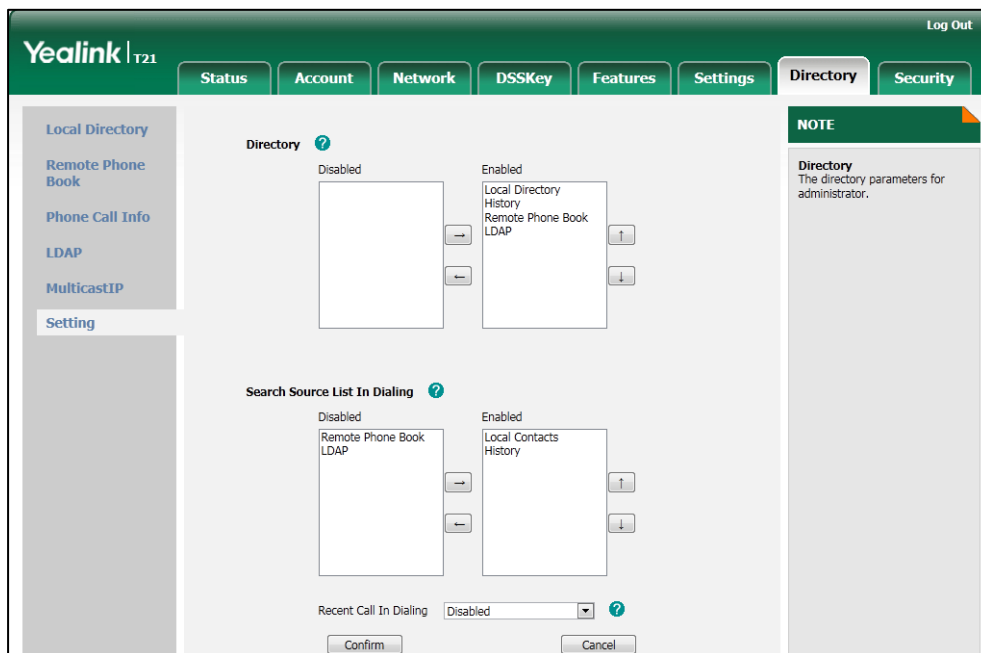

- Click **Confirm** to accept the change.

Note Directory is configurable via web user interface only.

To check the directory via phone user interface:

- Press the **Dir** soft key when the phone is idle.
The LCD screen displays the list(s) in the directory.

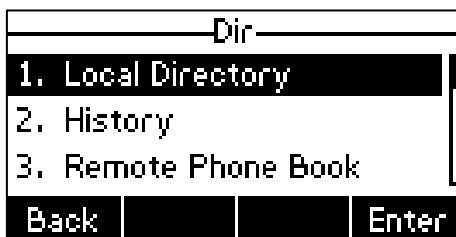

If there is only one list in the directory, press the **Dir** soft key to enter this list directly.

Local Directory

The built-in phone directory can store contact names and numbers. You can store up to 1000 contacts and 5 groups (including the default groups: Company, Family and Friend) in your phone's local directory; add new contacts and groups; edit, delete or search for a contact; or simply dial a contact number from the local directory.

Adding Groups



To add a group to the local directory:

1. Press the **Dir** soft key.

The IP phone enters the local directory directly as there is only Local Directory in the directory by default.



If Local Directory is removed from the directory, press **Menu->Dir->Local Directory** to enter the local directory.

2. Press the **AddGrp** soft key.
3. Enter the desired group name in the **Name** field.
4. Press  or  to select the desired group ring tone from the **Ring Tones** field.

If **Auto** is selected, this group will use the ring tone assigned to the account. For more information on ringtone for an account, refer to [Ring Tones](#) on page 25.

5. Press the **Add** soft key to accept the change or the **Back** soft key to cancel.

Editing Groups

To edit a group in the local directory:

1. Press the **Dir** soft key.

The IP phone enters the local directory directly as there is only Local Directory in the directory by default.





If Local Directory is removed from the directory, press **Menu->Dir->Local Directory** to enter the local directory.

2. Select the desired group.

3. Press the **Option** soft key, and then select **Detail** from the prompt list.



4. Press  or  to scroll through the group information and then edit.
5. Press the **Save** soft key to accept change or the **Back** soft key to cancel.

Deleting Groups

To delete a group from the local directory:

1. Press the **Dir** soft key.

The IP phone enters the local directory directly as there is only Local Directory in the directory by default.



If Local Directory is removed from the directory, press **Menu->Dir->Local Directory** to enter the local directory.

2. Select the desired group.
3. Press the **Option** soft key, and then select **Delete** from the prompt list.

The LCD screen prompts "Delete selected group?".



4. Press the **OK** soft key to confirm the deletion or the **Cancel** soft key to cancel.

You can also delete all groups by pressing the **Option** soft key and then select **Del All**. For more information, refer to the above steps.

Adding Contacts

You can add contacts to the local directory in the following ways:

- Manually
- From call history
- From remote phone book

Adding Contacts Manually

To add a contact to the local directory manually:

1. Press the **Dir** soft key.

The IP phone enters the local directory directly as there is only Local Directory in the directory by default.



If Local Directory is removed from the directory, press **Menu->Dir->Local Directory** to enter the local directory.

2. Select the desired group and then press the **Enter** soft key.
3. Press the **Add** soft key.
4. Enter the name and the office, mobile or other numbers in the corresponding fields.



5. Press **◀** or **▶**, or the **Switch** soft key to select the desired account from the **Account** field.

If **Auto** is selected, the phone will use the first available account when placing calls to the contact from the local directory.

6. Press **◀** or **▶**, or the **Switch** soft key to select the desired ring tone from the **Ring Tones** field.

If **Auto** is selected, this contact will use the ring tone assigned to the group.



- Press the **Add** soft key to accept the change or the **Back** soft key to cancel.

Note

If the contact has existed in the directory, the LCD screen will prompt "Contact name existed!".

Adding Contacts from Call History

To add a contact to the local directory from the call history:



- Press the **History** soft key.
- Press  or  to select the desired entry.
- Press the **Option** soft key, and then select **Add to Contacts** from the prompt list.



- Enter the contact name.
- Press the **Save** soft key to accept the change.
The entry is successfully saved to the local directory.

Adding Contacts from Remote Phone Book

To add a contact to the local directory from remote phone book:

- Press **Menu->Dir->Remote Phone Book**.
If Remote Phone Book is added to the directory, press **Dir->Remote Phone Book** to enter remote phone book.
- Press  or  to select the desired contact.
- Press the **Option** soft key, and then select **Add to Contacts** from the prompt list.
- Press the **Save** soft key to save the contact in the local directory.
If the contact has already existed in the local directory, the LCD screen will prompt "Overwrite the original contact?". Press the **OK** soft key to overwrite the original contact in local directory or the **Cancel** soft key to cancel.

For more information on remote phone book operating, refer to [Remote Phone Book](#) on page 40.

Editing Contacts

To edit a contact in the local directory:

1. Press the **Dir** soft key.

The IP phone enters the local directory directly as there is only Local Directory in the directory by default.



If Local Directory is removed from the directory, press **Menu->Dir->Local Directory** to enter the local directory.

2. Select the desired group and then press the **Enter** soft key.
3. Press \uparrow or \downarrow to select the desired contact.
4. Press the **Option** soft key, and then select **Detail** from the prompt list.
5. Press \uparrow or \downarrow to scroll through the contact information and then edit.



6. Press the **Save** soft key to accept change or the **Back** soft key to cancel.

Deleting Contacts



To delete a contact from the local directory:

1. Press the **Dir** soft key.

The IP phone enters the local directory directly as there is only Local Directory in the directory by default.



If Local Directory is removed from the directory, press **Menu->Dir->Local Directory** to enter the local directory.

2. Select the desired group and then press the **Enter** soft key.
3. Press  or  to select the desired contact.
4. Press the **Option** soft key, and then select **Delete** from the prompt list.

The LCD screen prompts “Delete selected item?”.

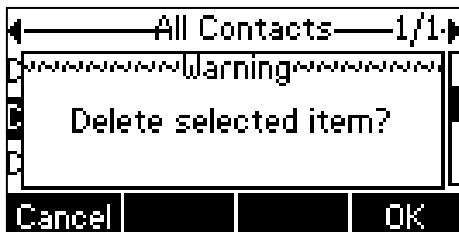

5. Press the **OK** soft key to confirm the deletion or the **Cancel** soft key to cancel.

Placing Calls to Contacts





To place a call to a contact from the local directory:

1. Press the **Dir** soft key.

The IP phone enters the local directory directly as there is only Local Directory in the directory by default.



If Local Directory is removed from the directory, press **Menu->Dir->Local Directory** to enter the local directory.

2. Select the desired group and then press the **Enter** soft key.
3. Press  or  to select the desired contact.
4. Do one of the following:
 - If only one number of the contact is stored in the local directory, press the **Send** soft key to dial out the number.
 - If multiple numbers of the contact are stored in the local directory, press the **Send** soft key to display a list of numbers.
Press  or  to select the desired number.
Press the **Send** soft key to dial out the number.

Searching for Contacts



To search for a contact in the local directory:

1. Press the **Dir** soft key.

The IP phone enters the local directory directly as there is only Local Directory in the directory by default.



If Local Directory is removed from the directory, press **Menu->Dir->Local Directory** to enter the local directory.

2. Press  or  to scroll to the **All Contacts** field.
3. Press the **Search** soft key.
4. Enter a few continuous characters of the contact name or number using the keypad.







The contacts whose name or number matches the characters entered will appear on the LCD screen. You can dial from the result list.

Search Source List in Dialing

You can search for a contact in your desired lists when the phone is in the dialing screen. The lists may contain Local Directory, History, Remote Phone Book and LDAP.

To configure search source list in dialing via web user interface:

1. Click on **Directory->Setting**.
2. In the **Search Source List In Dialing** block, select the desired list from the **Disabled** column and then click  .
The selected list appears in the **Enabled** column.
3. Repeat step 2 to add more lists to the **Enabled** column.
4. To remove a list from the **Enabled** column, select the desired list and then click  .
5. To adjust the display order of search results, select the desired list and then click  or  .

The LCD screen displays the search results in the adjusted order.

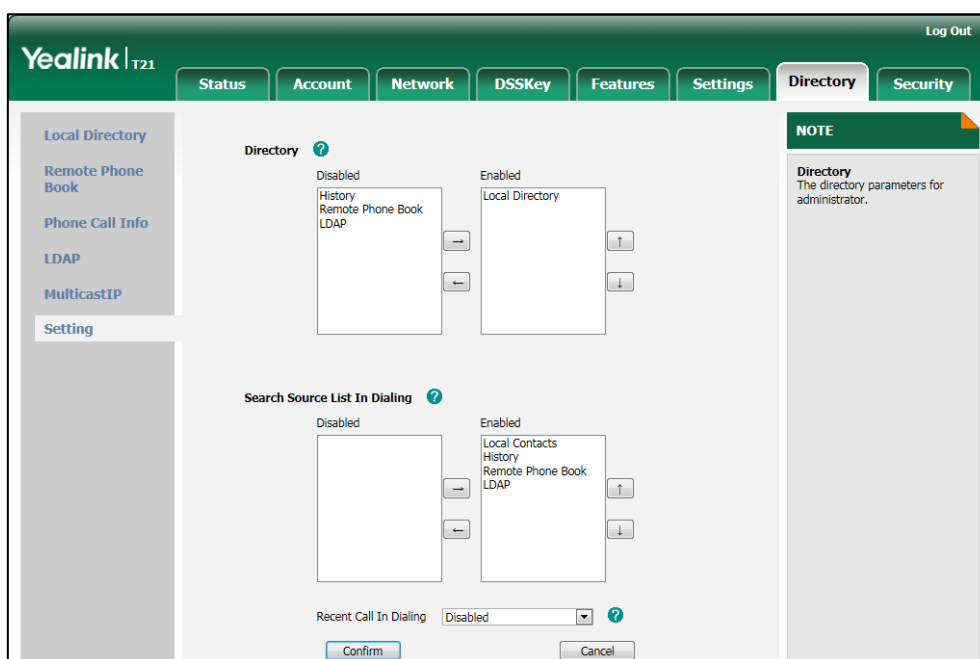



6. Click **Confirm** to accept the change.

Note

Search source list in dialing is configurable via web user interface only.

To search for a contact in the enabled search source lists:

1. Pick up the handset, press the speakerphone or press the line key.
2. Enter a few continuous characters of the contact name or number using the keypad.

The contacts in the enabled search source lists whose name or number matches the characters entered will appear on the LCD screen. You can press  or  to select the desired contact and then place a call to the contact.



Importing/Exporting Contact Lists

You can manage your phone's local directory via phone user interface or web user interface. But you can only import or export the contact list via web user interface.

To import an XML file of contact list via web user interface:

1. Click on **Directory->Local Directory**.
2. Click **Browse** to locate a contact list file (file format must be *.xml) from your local system.

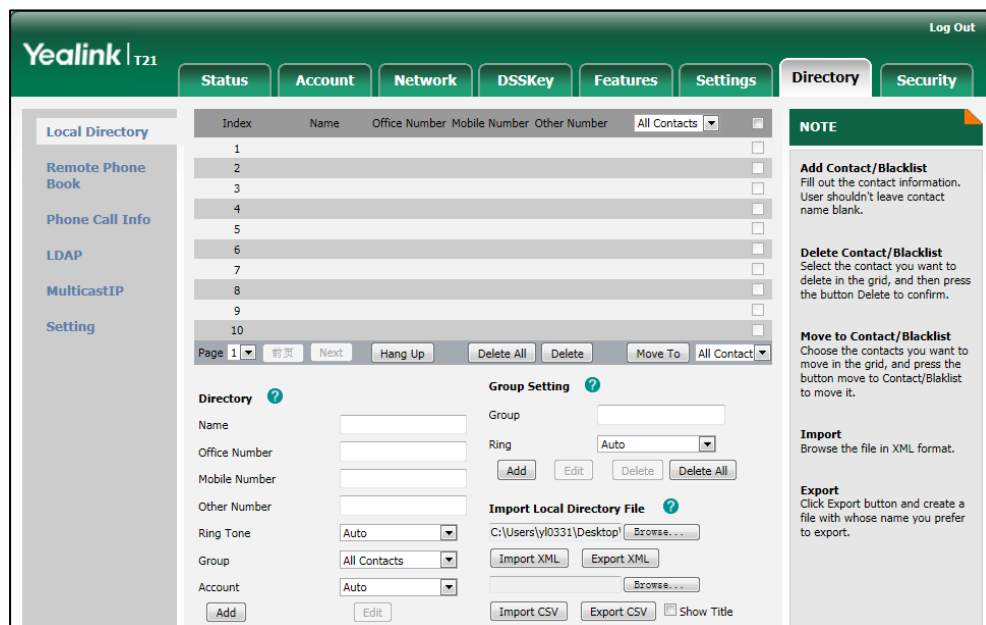

3. Click **Import XML** to import the contact list.
The web user interface prompts "The original contact will be covered, Continue?".
4. Click **OK** to complete importing the contact list.

To import a CSV file of contact list via web user interface:

1. Click on **Directory->Local Directory**.
2. Click **Browse** to locate a contact list file (file format must be *.csv) from your local system.
3. (Optional.) Check the **Show Title** checkbox.
It will prevent importing the title of the contact information which is located in the first line of the CSV file.
4. Click **Import CSV** to import the contact list.
5. (Optional.) Mark the **On** radio box in the **Delete Old Contacts** field.
It will delete all existing contacts while importing the contact list.

- (Optional.) Select the contact information you want to import into the local directory from the pull down list of **Index**.

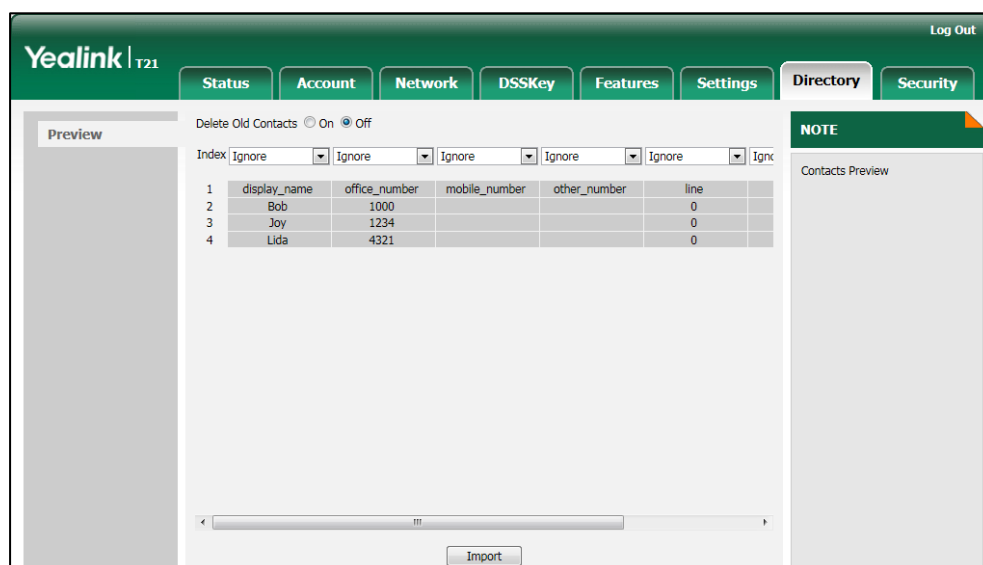

- Click **Import** to complete importing the contact list.

To export contact list via web user interface:

- Click on **Directory->Local Directory**.
- Click **Export XML** (or **Export CSV**).
- Click **Save** to save the contact list to your local system.

Note Importing/exporting contact lists are configurable via web user interface only.

Blacklist

The built-in phone directory can store names and numbers for a blacklist. You can store up to 30 contacts in your phone's blacklist; add, edit, delete or search for a contact in the blacklist; even dial a contact number from the blacklist, but any incoming call from the blacklist will be rejected automatically.

To add a contact to the blacklist manually:

- Press **Menu->Dir->Blacklist**.
- Press the **Add** soft key.

3. Enter the name and the office, mobile or other numbers in the corresponding fields.



4. Press or , or the **Switch** soft key to select the desired account from the **Account** field.

If **Auto** is selected, the phone will use the first available account when placing calls to the contact from the blacklist.

5. Press the **Add** soft key to accept the change or the **Back** soft key to cancel.

To add a contact to the blacklist from local directory:

1. Press the **Dir** soft key.

The IP phone enters the local directory directly as there is only Local Directory in the directory by default.



If Local Directory is removed from the directory, press **Menu->Dir->Local Directory** to enter the local directory.

2. Press or to select the desired contact.
3. Press the **Option** soft key and then select **Add to Blacklist** from the prompt list.

The LCD screen prompts "Move selected to blacklist?".



4. Press the **OK** soft key to confirm the setting.

For more operating instructions on editing, deleting, placing calls to and/or searching for contacts in the blacklist, refer to the operating instructions of [Local Directory](#) on page 28.

Remote Phone Book

You can access your corporate directory through your phone. You can add local contacts, search for a contact, or simply dial a contact number from the corporate directory.

You can configure your new phone to access up to 5 corporate directories. The phone supports up to 2000 corporate directory entries. For the access URL of the corporate directory, contact your system administrator.

To configure an access URL for remote phone book via web user interface:

1. Click on **Directory->Remote Phone Book**.
2. Enter the access URL in the **Remote URL** field.
3. Enter the name in the **Display Name** field.

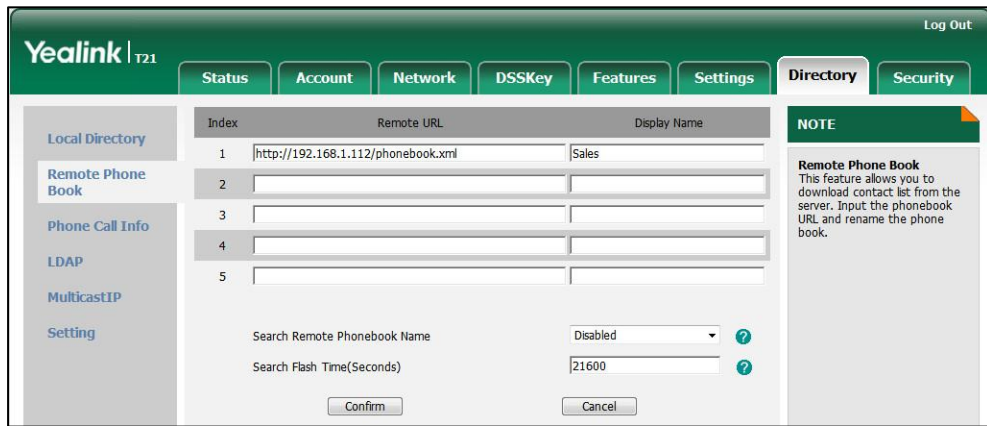

4. Click **Confirm** to accept the change.

Note



An access URL for remote phone book is configurable via web user interface only.

To access your corporate directory via phone user interface:

1. Press **Menu->Dir->Remote Phone Book**.

If Remote Phone Book is added to the directory, press **Dir->Remote Phone Book** to enter remote phone book.



2. Press  or  to select the desired remote group, and then press the **Enter** soft key.

The phone connects to load the corporate directory, and then the corporate contact list appears on the LCD screen.

3. Press the **Back** soft key to back to the previous interface.

To search for a contact in the corporate directory:

1. Press **Menu->Dir->Remote Phone Book**.

If Remote Phone Book is added to the directory, press **Dir->Remote Phone Book** to enter remote phone book.

2. Select the desired remote group, and then press the **Enter** soft key to load the corporate directory.
3. Press the **Search** soft key.
4. Enter a few continuous characters of the contact name or number using the keypad.





The contacts whose name or number matches the characters entered will appear on the LCD screen. You can dial from the result list.

To place a call from the corporate directory:

1. Press **Menu->Dir->Remote Phone Book**.

If Remote Phone Book is added to the directory, press **Dir->Remote Phone Book** to enter remote phone book.

2. Press  or  to select the desired remote group, and then press the **Enter** soft key to load the corporate directory.
3. Select the desired contact in the corporate directory.
4. Press the **Send** soft key.

In addition, you can enable the phone to present the caller identity stored in the corporate directory when receiving a call.

To enable the presentation of caller identity stored in remote phone book via web user interface:

1. Click on **Directory->Remote Phone Book**.
2. Select **Enabled** from the pull-down list of **Search Remote Phonebook Name**.

3. Enter the refresh period of corporate directory in the **Search Flash Time (Seconds)** field.

The default value is 21600 seconds.

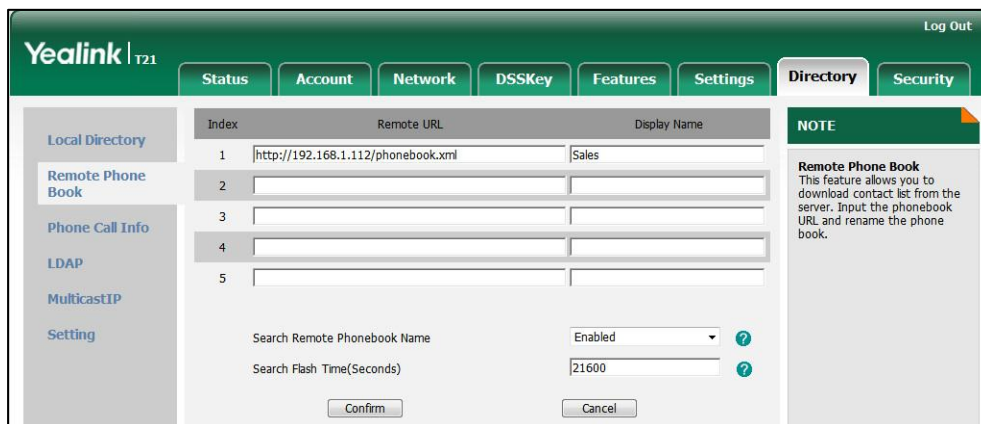

4. Click **Confirm** to accept the change.

Call History Management

The SIP-T21P/SIPT21 IP phone maintains call history lists of Placed Calls, Received Calls, Missed Calls and Forwarded Calls. Call history lists support 100 entries in all. You can view the call history, place a call, add a contact or delete an entry from the call history list. You should enable history record in advance.

To enable history record via phone user interface:

1. Press **Menu->Features->History Setting**.
2. Press **◀** or **▶**, or the **Switch** soft key to select **Enable** from the **History Record** field.



3. Press the **Save** soft key to accept the change or the **Back** soft key to cancel.





To view the call history:

1. Press the **History** soft key.
The LCD screen displays **All Calls** list.
2. Press **◀** or **▶** to switch between **All Calls**, **Placed Calls**, **Received Calls**, **Missed Calls** and **Forwarded Calls**.
3. Press **▲** or **▼** to select the desired entry.





4. Press the **Option** soft key, and then select **Detail** from the prompt list.

The detailed information of the entry appears on the LCD screen.

To place a call from the call history list:





1. Press the **History** soft key.
2. Press  or  to switch between **All Calls, Placed Calls, Received Calls, Missed Calls** and **Forwarded Calls**.
3. Press  or  to scroll to the desired entry.
4. Press the **Send** soft key.

To add a contact to the local directory or blacklist from the call history list:



1. Press the **History** soft key.
2. Press  or  to switch between **All Calls, Placed Calls, Received Calls, Missed Calls** and **Forwarded Calls**.
3. Press  or  to scroll to the desired entry.
4. Press the **Option** soft key, and then select **Add to Contacts** (or **Add to Blacklist**) from the prompt list.
5. Enter the desired values in the corresponding fields, and then press the **Save** soft key.

For more information, refer to [Contact Management](#) on page 27.

To delete an entry from the call history list:

1. Press the **History** soft key.
2. Press  or  to switch between **All Calls, Placed Calls, Received Calls, Missed Calls** and **Forwarded Calls**.
3. Press  or  to scroll to the desired entry.
4. Press the **Delete** soft key.

To delete all entries from the call history list:

1. Press the **History** soft key.
2. Press  or  to switch between **All Calls, Placed Calls, Received Calls, Missed Calls** and **Forwarded Calls**.
3. Press the **Option** soft key, and then select **Del All** from the prompt list.
4. Press the **OK** soft key.

The LCD screen prompts "Delete all records?".



5. Press the **OK** soft key to confirm the deletion or the **Cancel** soft key to cancel.

System Customizations

Logo Customization

You can upload your custom logo which will be shown on the idle screen.

To upload a custom logo via web user interface:

1. Click on **Features->General Information**.
2. Select **Custom Logo** from the pull-down list of **Use Logo**.

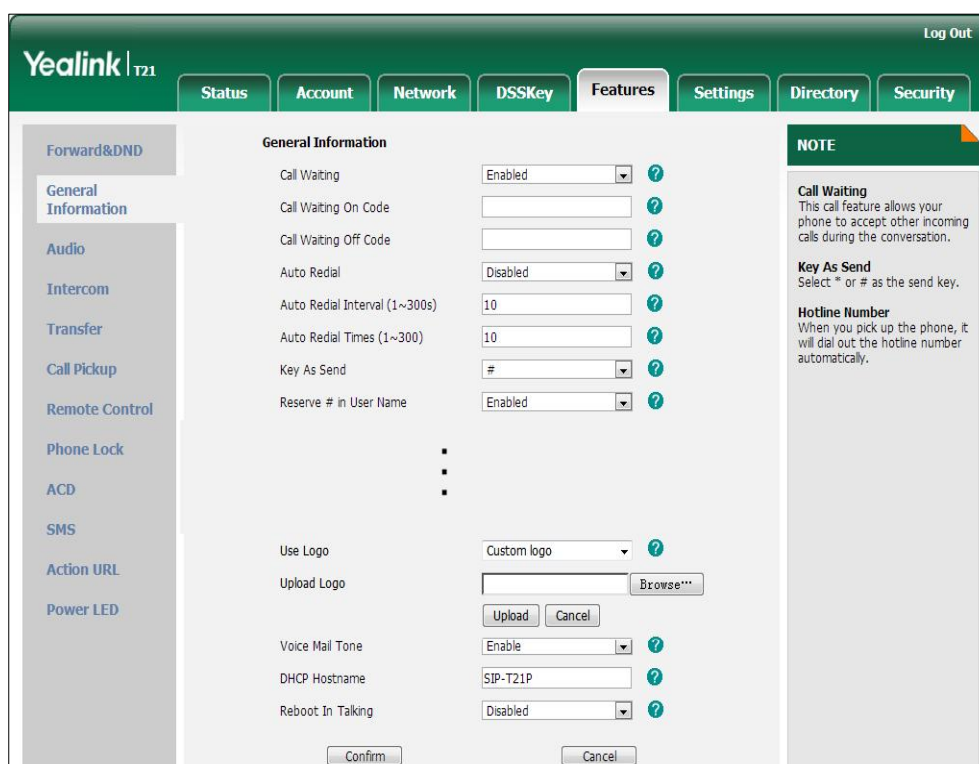

3. Click **Browse** to locate the logo file from your local system.
4. Click **Upload** to upload the file.

5. Click **Confirm** to accept the change.

Note

The logo file format must be *.dob, contact your system administrator for more information.

Logo customization is configurable via web user interface only.

Headset Use

Physically connect your headset and activate the headset mode for use. For more information on physically connecting a headset, refer to [Phone Installation](#) on page 11.

Headset Mode Activation/Deactivation

To activate the headset mode:

1. Press  on the phone.

The headset icon on the idle screen indicates that the headset mode is activated.

Press the line key or the **Answer** soft key to answer a call. The call will connect to your headset automatically. Enter the desired number and press the **Send** soft key, then the phone will place a call using the headset automatically. For more information on using the headset to place a call, refer to [Placing Calls](#) on page 63.

To deactivate the headset mode:

1. Press  again on the phone.

The headset icon disappears from the idle screen indicates the headset mode is deactivated.

Headset Prior

You can use headset in priority when enabling headset prior. This feature is especially useful for permanent or full-time headset users.

To enable headset prior via web user interface:

1. Click on **Features->General Information**.

2. Select **Enabled** from the pull-down list of **Headset Prior**.

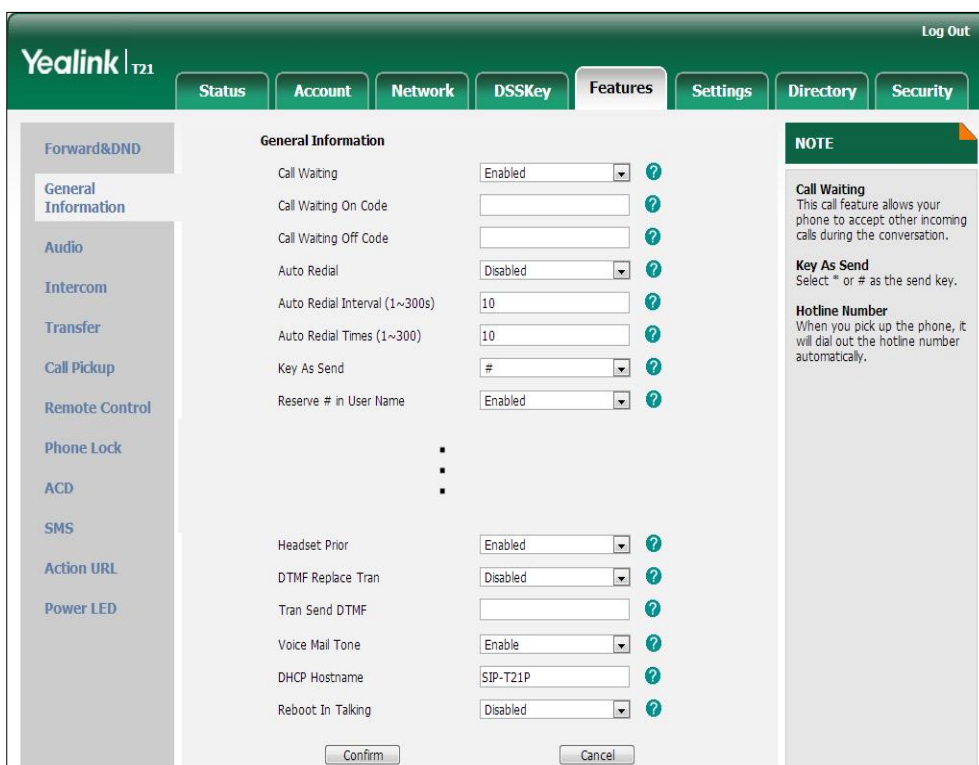

3. Click **Confirm** to accept the change.

To use headset prior feature, you should activate the headset mode in advance:

1. Physically connect the headset.
2. Press  to activate the headset mode.

Note If headset prior is enabled, the headset mode will not be deactivated until you press the **HEADSET** key again.
Headset prior is configurable via web user interface only.

DSS Keys

Two types of DSS keys: Line Keys and Programmable Keys. The details will be introduced in the following. The SIP-T21P/SIP-T21 IP phone supports 2 line keys.

Line Keys

You can assign predefined functionalities to the line keys to have quick access to features such as call return and voice mail. The line key LEDs will indicate status when the keys are assigned with particular features, such as BLF. The default key type of each line key is Line.

To configure the line key via phone user interface:

1. Press **Menu->Features->DSS Keys**.
2. Select the desired line key, and then press the **Enter** soft key.
3. Select the desired key type from the **Type** field.
4. (Optional.) Select the desired key event from the **Key Type** field.
5. (Optional.) Select the desired line from the **Account ID** field.
6. (Optional.) Enter the corresponding value in the **Value** field.
7. (Optional.) Enter the corresponding value in the **Extension** field.
8. Press the **Save** soft key to accept the change or the **Back** soft key to cancel.

Line key is configurable via web user interface at the path **DSSKey->Line Key**.

Note

When the phone is idle, you can also long press the line key to configure it directly on the phone.

Common used line key features are explained in the following subchapters in detail:

- Speed Dial
- Voice Mail
- Directed Pickup
- Group Pickup
- DTMF
- Prefix
- Local Group
- XML Group
- XML Brower
- LDAP
- Conference
- Forward
- Transfer
- Hold
- DND
- SMS
- Group Listening
- Zero Touch
- Keypad Lock
- Directory

For more information, contact your system administrator.

Speed Dial

You can use this key feature to speed up dialing numbers often used or hard to remember.

Dependencies: *Type (Speed Dial)*

Account ID (the account this feature will be applied to)

Value (the number you want to dial out)

Usage: Press the DSS key to dial out the number specified in the **Value** field, using the account selected from the **Account ID** field.

Voice Mail

You can use this key feature to connect voice mail quickly. For more information, refer to [Voice Mail](#) on page 111.

Dependencies: *Type (Key Event)*

Key Type (Voice Mail)

Account ID (the account this feature will be applied to)

Value (the voice mail access code)

Usage: Press the DSS key to dial out the voice mail access code, you can follow the voice prompt to listen to the voice mails.

Directed Pickup

You can use this key feature to answer someone else's incoming call on the phone.

Dependencies: *Type (Key Event)*

Key Type (Directed Pickup)

Account ID (the account this feature will be applied to)

Value (the directed pickup code followed by the specific phone number)

Usage: Press the DSS key on your phone when the specific phone number receives an incoming call. The call is answered on your phone.

Group Pickup

You can use this key feature to answer incoming calls in a group that is associated with their own group.

Dependencies: *Type (Key Event)*

Key Type (Group Pickup)

Account ID (the account this feature will be applied to)

Value (the group pickup feature code)

Usage: Press the DSS key on your phone when a phone number in the group receives an incoming call. The call is answered on your phone.

DTMF

You can use this key feature to send the specification of arbitrary key sequences via DTMF.

Dependencies: *Type (Key Event)*

Key Type (DTMF)

Value (DTMF sequence)

Usage: Press the DSS key during an active call to send the key sequence specified in the **Value** field.

Note

DTMF sequence only contains "0-9", "*", "#" and "A-D".

Prefix

You can use this key feature to add a specified prefix number before the dialed number.

Dependencies: *Type (Key Event)*

Key Type (Prefix)

Value (the prefix number)

Usage: Press the DSS key when the phone is idle, then the phone will enter into the dialing screen and display the prefix number which you specified in the **Value** field. You can enter other digits and then dial out.

Local Group

You can use this key feature to access the group in the local directory quickly. For more information, refer to [Local Directory](#) on page 28.

Dependencies: *Type (Key Event)*

Key Type (Local Group)

Local Group (the group you want to access)

Usage: Press the DSS key to access the group specified in the **Local Group** field.

XML Group

You can use this key feature to access the remote group in your corporate directory quickly. You should configure remote phone book in advance. For more information, refer to [Remote Phone Book](#) on page 40.

Dependencies: *Type (Key Event)*

Key Type (XML Group)

Phone Book Name (the remote group you want to access if the remote phone book is configured)

Usage: Press the DSS key to access the remote group specified in the **Phone Book Name** field.

XML Browser

You can use this key feature to access the XML browser quickly. The XML browser allows you to create custom services which meet your functional requirements on the server. You can customize practical applications, such as weather report, stock information, Google search, etc.

Dependencies: *Type (XML Browser)*

Value (the access URL for xml browser)

Usage: Press the DSS key to access the XML browser specified in the **Value** field.

LDAP

You can use this key feature to access the LDAP search interface quickly.

Dependencies: *Type (Key Event)*

Key Type (LDAP)

Usage:

1. Press the DSS key to access the LDAP search interface.
2. Enter a few continuous characters of the contact name or number using the keypad.

The contacts whose name or number matches the characters entered will appear on the LCD screen.

Conference

You can use this key feature to set up a conference call. For more information, refer to [Conference](#) on page 84.

Dependencies: *Type (Key Event)*

Key Type (Conf)

Value (the number you want to add to the conference)

Usage: Press the DSS key during an active call to set up a conference with the number specified in the **Value** field.

Note

When you leave the **Value** field blank, the DSS key performs the same function as the **Conf** soft key during a call.

Forward

You can use this key feature to forward an incoming call to someone else. For more information, refer to [Call Forward](#) on page 76.

Dependencies: *Type (Key Event)*

Key Type (Forward)

Value (the number you want to forward to)

Usage: Press the DSS key to forward an incoming call to the number specified in the **Value** field.

Note

When you leave the **Value** field blank, the DSS key performs the same function as the **Fwd** soft key when receiving an incoming call.

Transfer

You can use this key feature to handle the call differently depending on the transfer mode on DSS key when there is an active call on the phone.

Dependencies: *Type (Key Event)*

Key Type (Tran)

Value (the number you want to transfer to)

Usage:

- When the transfer mode on DSS key is **Blind Transfer**, press the DSS key to complete the blind transfer to the number specified in the **Value** field.
- When the transfer mode on DSS key is **Attended Transfer**, press the DSS key to dial out the number specified in the **Value** field, and then you can perform the attended or semi-attended transfer.
- When the transfer mode on DSS key is **New Call**, press the DSS key to place a new call to the number specified in the **Value** field.

Note

Transfer mode on DSS key is configurable via web user interface at the path **Features->Transfer->Transfer Mode Via Dsskey**.

When you leave the **Value** field blank, the DSS key performs the same function as the **TRAN** key or the **Tran** soft key during a call. For more information, refer to [Call Transfer](#) on page 82.

Hold

You can use this key feature to place an active call on hold or retrieve a held call.

Dependencies: *Type (Key Event)*

Key Type (Hold)

Usage:

1. Press the DSS key during an active call to place the call on hold.
2. Press the DSS key again to retrieve the held call.

DND

You can use this key feature to activate or deactivate DND. You can also use this key feature to access the custom DND interface. For more information, refer to [Do Not Disturb \(DND\)](#) on page 73.

Dependencies: *Type (Key Event)*

Key Type (DND)

Usage:

When DND is in phone mode:

1. Press the DSS key to activate DND.
2. Press the DSS key again to deactivate DND.

When DND is in custom mode:

1. Press the DSS key to access the custom DND interface.
2. Activate or deactivate DND for one or all accounts.

Note

When DND is activated, the incoming calls will be rejected automatically.

SMS

You can use this key feature to quick access the short message service. For more information, refer to [Short Message Service \(SMS\)](#) on page 109.

Dependencies: *Type (Key Event)*

Key Type (SMS)

Usage: Press the DSS key when the phone is idle to access the short message service.

Group Listening

You can use this key feature to activate the Speakerphone and Handset/Headset mode at the same time. It is suitable for the group conversation which has more than one person at one side. You are able to speak and listen through the handset/headset, meanwhile the others nearby can only listen through the speaker.

Dependencies: *Type (Key Event)*

Key Type (Group Listening)

Usage:

1. During a call, press the DSS key to activate the group listening mode.
You can then speak and listen through the handset/headset, other persons at your side can listen through the speaker at the same time.
2. Press the DSS key again to deactivate the group listening mode.

Zero Touch

You can use this key feature to configure auto provision and network parameters quickly.

Dependencies: *Type (Key Event)*

Key Type (Zero Touch)

Usage:

1. Press the DSS key to access the zero touch screen.
2. Press the **OK** soft key in a few seconds.

3. Configure the network parameters in the corresponding fields.
4. Press the **Next** soft key.
5. Configure the auto provision parameters in the corresponding fields.
6. Press the **OK** soft key.

The phone will reboot to update configurations.

Keypad Lock

You can use this key feature to immediately lock the keypad of your phone instead of long pressing . For more information, refer to [Keypad Lock](#) on page 21.

Dependencies: *Type (Keypad Lock)*

Usage: Press the DSS key to immediately lock the keypad of your phone instead of long pressing .

Directory

You can use this key feature to easily access frequently used lists. For more information, refer to [Directory](#) on page 27.

Dependencies: *Type (Dir)*

Usage: Press the DSS key to immediately access to frequently used lists.

Note

The DSS key performs the same function as the **Dir** soft key when the phone is idle.

Programmable Keys

You can customize the soft keys, navigation keys and function keys on the keypad.

To customize the programmable keys via web user interface:

1. Click on **DSSKey->Programmable Key**.
2. Customize specific features for these keys.

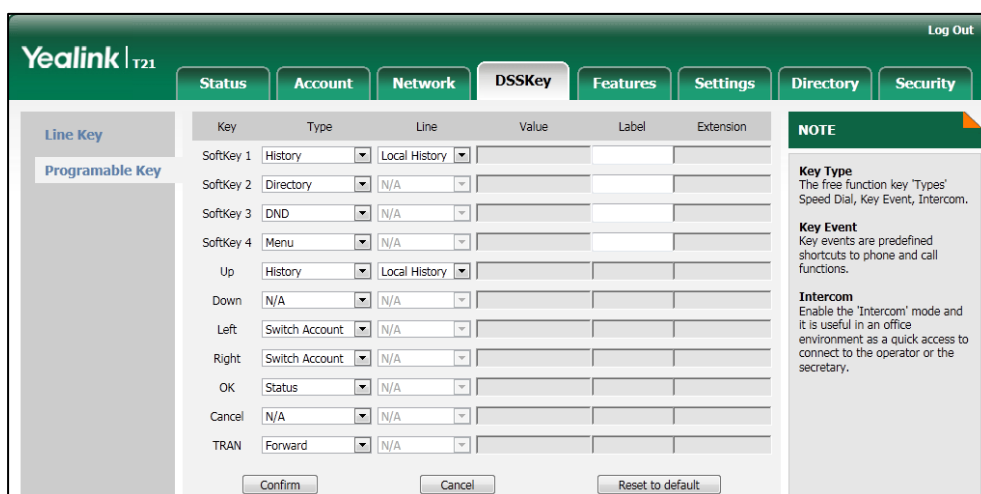

3. Click **Confirm** to accept the change.

You can click **Reset to default** to reset custom settings to defaults.

Note

Programmable keys are configurable via web user interface only.

Account Management

You can register one or multiple accounts on the SIP-T21P/SIP-T21 IP phone. You can also configure each line key to associate with an account or configure multiple line keys to associate with an account.

Account Registration

To register an account via phone user interface:

1. Press **Menu->Settings->Advanced Settings** (password: admin) ->**Accounts**.
2. Select the desired account and then press the **Enter** soft key.
3. Select **Enable** from the **Activation** field.

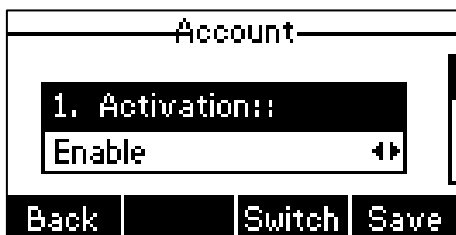

4. Enter the desired values in the **Label**, **Display Name**, **Register Name**, **User Name**, **Password** and **Sip Server1/2** fields respectively. Contact your system administrator for more information.
 5. Press the **Save** soft key to accept the change or the **Back** soft key to cancel.
- You can repeat steps 2 to 5 to register more accounts.

To disable an account via phone user interface:

1. Press **Menu->Settings->Advanced Settings** (password: admin) ->**Accounts**.
2. Select the desired account and then press the **Enter** soft key.
3. Select **Disable** from the **Activation** field to disable the account.
4. Press the **Save** soft key to accept the change or the **Back** soft key to cancel.

Account registration is configurable via web user interface at the path **Account->Register**.

Multiple Line Keys per Account

You can configure multiple line keys to associate with an account. This enhances call visualization and simplifies call handling.

Incoming calls to this account will be distributed evenly among the available line keys. Outgoing calls will be distributed similarly.

Dial Plan

Dial plan is a string of characters that governs the way your SIP-T21P/SIP-T21 IP phone processes the inputs received from your phone keypad. The SIP-T21P/SIP-T21 IP phone supports the following dial plan features:

- [Replace Rule](#)
- [Dial-now](#)
- [Area Code](#)
- [Block Out](#)

The basic expression syntax you need to know:

.	The dot "." can be used as a placeholder or multiple placeholders for any character. Example: "12." would match "123", "1234", "12345", "12abc", etc.
x	An "x" can be used as a placeholder for any character. Example: "12x" would match "121", "122", "123", "12a", etc.
[]	The square brackets "[]" can be used as a placeholder for a single character which matches any of a set of characters. Example: "91[5-7]1234" would match "9151234", "9161234", "9171234".
()	The parentheses "()" can be used to group together patterns, for instance, to logically combine two or more patterns. Example: "91([5-7])1(x)" would match "91511", "91618", "91715", etc.
\$	The "\$" should be followed by the sequence number of a parenthesis. The "\$" plus the sequence number means the whole character or characters placed in the parenthesis. The number directs to the right parenthesis when there are more than one. Example: A replace rule configuration: Prefix: "9([5-7]) (.)", Replace: "5\$2". When you enter "96123" to dial out on your phone, the number will be replaced as "5123" and then dialed out. "\$2" means the characters in the second parenthesis, that is, "123".

Replace Rule

You can configure one or more replace rules (up to 100) to remove the specified string and replace it with another string. You can configure a pattern with wildcards (refer to the expression syntax in the table above), so that any string that matches the pattern will be replaced. This feature is convenient for you to dial out a long number. For example, a replace rule is configured as "Prefix: 1" and "Replace: 1234567". When trying to dial out the number "1234567", you just need to enter "1" on the phone and then press the Send soft key.

To add a replace rule via web user interface:

1. Click on **Settings->Dial Plan->Replace Rule**.
2. Enter the string (e.g., 1) in the **Prefix** field.
3. Enter the string (e.g., 1234) in the **Replace** field.
4. Enter the desired line ID in the **Account** field or leave it blank.

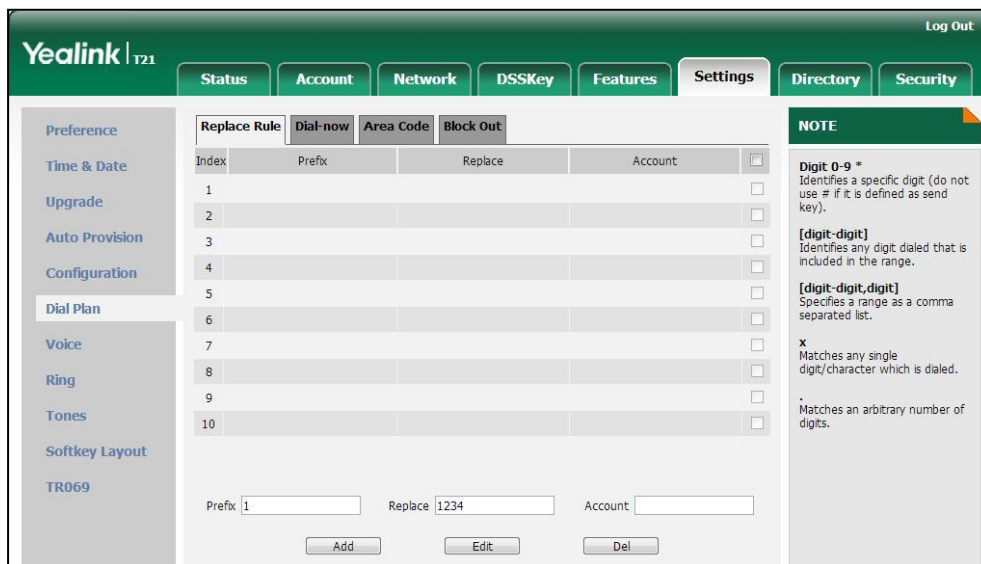

5. Click **Add** to add the replace rule.

When you enter the number “1” using the keypad and then press the **Send** soft key, the phone will dial out “1234” instead.

Note

The valid values of **Account** field can be one or two digits among 1 and 2. Each digit must be separated by a comma. For example, when you enter the value “1, 2” in the **Account** field, this replace rule will apply to account1 and account2.

If you leave the **Account** field blank or enter 0, the replace rule will apply to all accounts.

To edit a replace rule via web user interface:

1. Click on **Settings->Dial Plan->Replace Rule**.
2. Select the desired replace rule by checking the check box.
3. Edit the values in the **Prefix** and **Replace** fields.
4. Enter the desired line ID in the **Account** field or leave it blank.
5. Click **Edit** to accept the change.

To delete one or more replace rules via web user interface:

1. Click on **Settings->Dial Plan->Replace Rule**.
2. Select one or more replace rules by checking the check box(es).

3. Click **Del** to delete the replace rule(s).

Note Replace rule is configurable via web user interface only.

Dial-now

You can configure one or more dial-now rules (up to 100) on your phone. When the dialed out number matches the dial-now string, the number will be dialed out automatically. For example, a dial-now rule is configured as "2xx", then any entered three-digit string beginning with 2 will be dialed out automatically on the phone.

To add a dial-now rule via web user interface:

1. Click on **Settings->Dial Plan->Dial-now**.
2. Enter the desired value (e.g., 1234) in the **Rule** field.
3. Enter the desired line ID in the **Account** field or leave it blank.

For more information on the valid values of **Account** field, refer to [Replace Rule](#) on page 55.

The screenshot shows the Yealink T21 web interface. The top navigation bar includes 'Status', 'Account', 'Network', 'Dsskey', 'Features', 'Settings', 'Directory', and 'Security'. The 'Settings' menu is expanded to show 'Dial Plan', which is further expanded to 'Dial-now'. The main content area features a table with the following structure:

Index	Dial-now Rule	Account	
1			<input type="checkbox"/>
2			<input type="checkbox"/>
3			<input type="checkbox"/>
4			<input type="checkbox"/>
5			<input type="checkbox"/>
6			<input type="checkbox"/>
7			<input type="checkbox"/>
8			<input type="checkbox"/>
9			<input type="checkbox"/>
10			<input type="checkbox"/>

Below the table, there are two input fields: 'Rule 1234' and 'Account'. At the bottom of this section are three buttons: 'Add', 'Edit', and 'Del'. On the right side, there is a 'NOTE' box with the text 'settings-dialplan-note'. A left sidebar contains various menu items like 'Preference', 'Time&Date', 'Upgrade', 'Auto Provision', 'Configuration', 'Dial Plan', 'Voice', 'Ring', 'Tones', 'Softkey Layout', and 'TR069'.

4. Click **Add** to add the dial-now rule.

When you enter the number "1234" using the keypad, the phone will dial out "1234" automatically without pressing any key.

Note You can also edit or delete the dial-now rule, refer to [Replace Rule](#) on page 55 for more information.

Dial-now rule is configurable via web user interface only.

Delay Time for Dial-now Rule

You can configure the delay time for dial-now rules. That is, you can configure your

phone to dial out the phone number automatically, which matches a dial-now rule, after the specified delay time.

To configure the delay time for dial-now rule via web user interface:

1. Click on **Features->General Information**.
2. Enter the time within 1-14 (in seconds) in the **Time-Out for Dial-Now Rule** field.

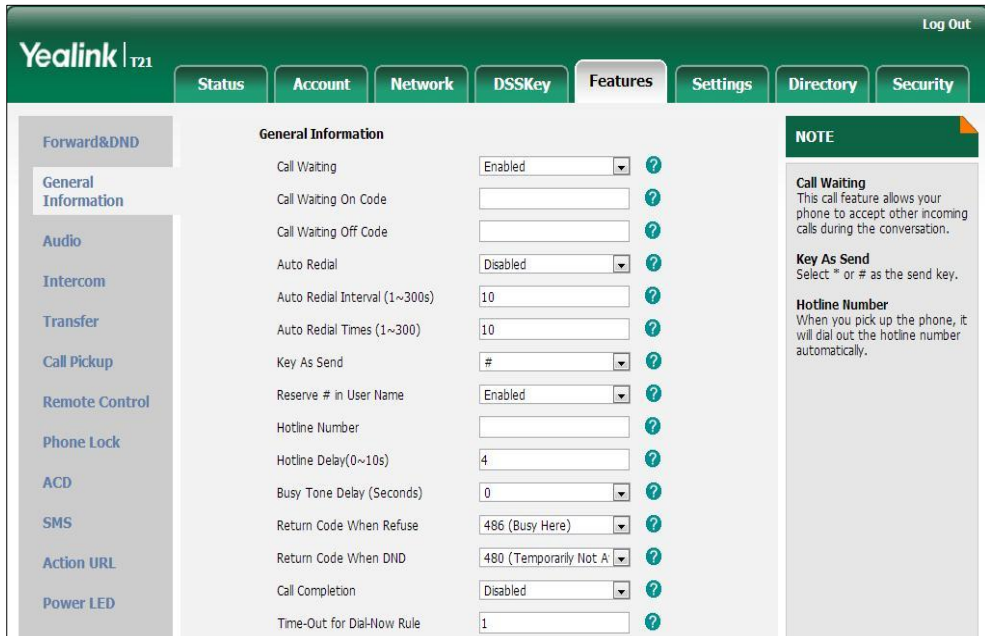

3. Click **Confirm** to accept the change.

Note

Delay time for dial-now rule is configurable via web user interface only.

Area Code

Area codes are also known as Numbering Plan Areas (NPAs). They usually indicate geographical areas in a country. This feature is necessary only when dialing the number outside the code area. For example, area code is configured as “Code: 0592, Min Length: 4, Max Length: 11”, then when you dial out the number “56789”, which has the digits between 4 to 11, the phone will add the area code and dial out the number “059256789”. You can only configure one area code rule on your phone.

To configure the area code via web user interface:

1. Click on **Settings->Dial Plan->Area Code**.
2. Enter the desired values in the **Code**, **Min Length (1-15)** and **Max Length (1-15)** fields.
3. Enter the desired line ID in the **Account** field or leave it blank.

For more information on the valid values of **Account** field, refer to [Replace Rule](#) on page 55.

4. Click **Confirm** to accept the change.

Note Area code is configurable via web user interface only.

Block Out

You can block some specific numbers from being dialed on your phone. When you dial a block out number on your phone, the dialing will fail and the LCD screen will prompt "Forbidden Number". You can add 10 block out rules at most on your phone.

To add a block out number via web user interface:

1. Click on **Settings->Dial Plan->Block Out**.
2. Enter the desired value in the **BlockOut Number** field.
3. Enter the desired line ID in the **Account** field or leave it blank.

For more information on the valid values of **Account** field, refer to [Replace Rule](#) on page 55.

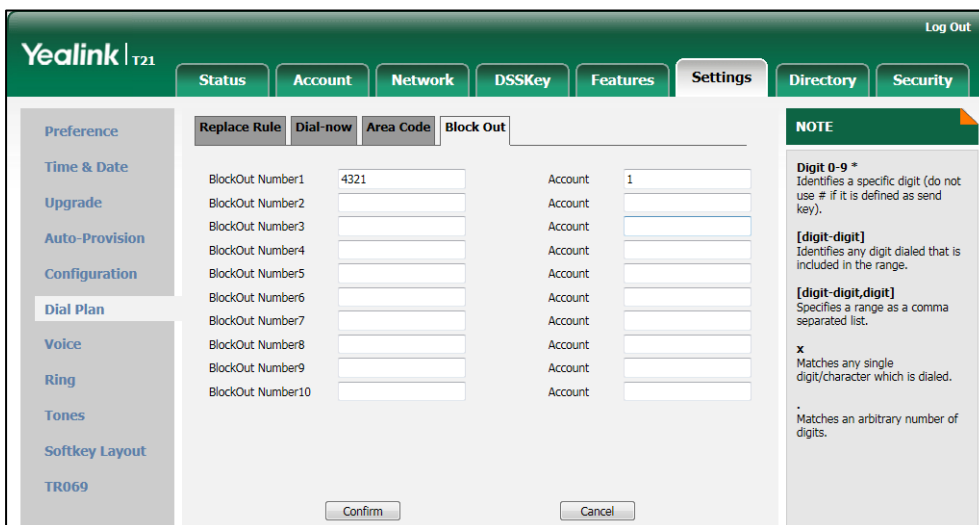

4. Click **Confirm** to add the block out number.

Note Block out number is configurable via web user interface only.

Emergency Number

Public telephone networks in countries around the world have a single emergency telephone number (emergency services number), that allows a caller to contact local emergency services for assistance when necessary. The emergency telephone number may differ from country to country. It is typically a three-digit number so that it can be easily remembered and dialed quickly. Some countries have different emergency numbers for different emergency services.

You can specify the emergency telephone number on the IP phone for contacting the emergency services in an emergency situation.

Note Contact your local phone service provider for available emergency numbers in your area.

To specify emergency numbers via web user interface:

1. Click on **Features->Phone Lock**.
2. Enter the emergency number in the **Emergency** field.

For multiple numbers, enter a comma between every two emergency numbers. The default emergency numbers are 110, 911 and 120.

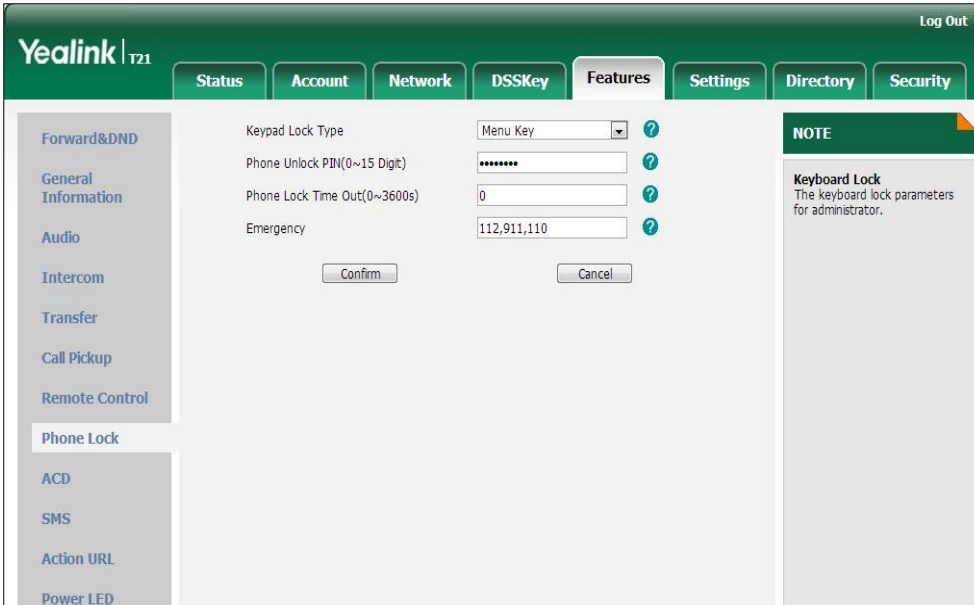

3. Click **Confirm** to accept the change.

Note Emergency number is configurable via web user interface only.

Live Dialpad

You can enable live dialpad on the SIP-T21P/SIP-T21 IP phone, which enables the IP phone to automatically dial out the phone number without pressing the send key. You can also configure a delay, where the phone will dial out the phone number automatically after the specified period of time.

To enable live dialpad via web user interface:

1. Click on **Settings->Preference**.
2. Select **Enabled** from the pull-down list of **Live Dialpad**.

- Enter the desired delay time in the **Inter Digit Time (1~14s)** field.

The default delay time is 4s.

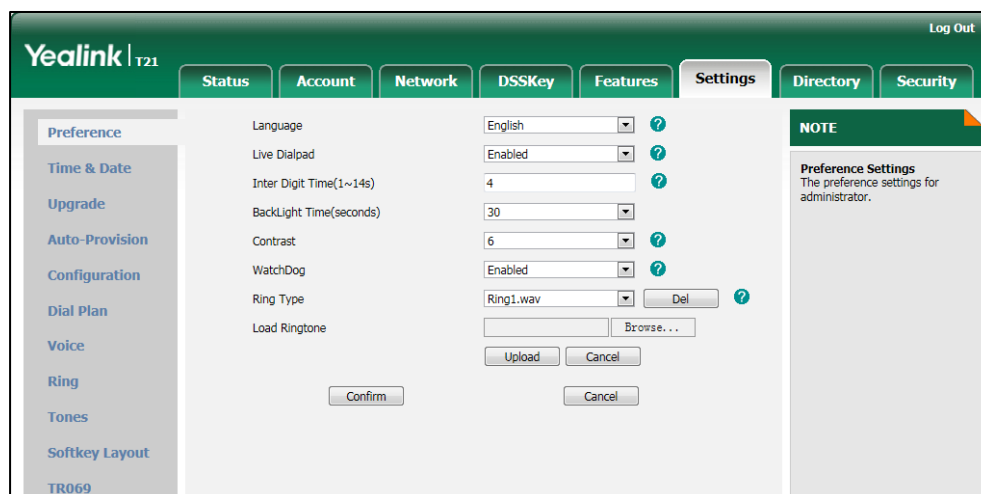

- Click **Confirm** to accept the change.

Note

Live dialpad is configurable via web user interface only.

Hotline

You can dial a hotline number immediately upon lifting the handset, pressing the Speakerphone key or pressing a line key. You can also configure a delay, where the phone will dial out the hotline number automatically after the specified period of time.

To configure the hot line number via phone user interface:

- Press **Menu->Features->Hotline**.
- Enter the desired number in the **Number** field.



- Enter the delay time (in seconds) in the **Hotline Time-out** field.
The valid values range from 0 to 10.
- Press the **Save** soft key to accept the change or the **Back** soft key to cancel.

Hotline is configurable via web user interface at the path **Features->General Information**.

Basic Call Features

The SIP-T21P/SIP-T21 IP phone is designed to be easily used like a regular phone on a public switched telephone network (PSTN). You can place calls, answer calls, transfer a call to someone else, or conduct a conference call.

This chapter provides basic operating instructions for the SIP-T21P/SIP-T21 IP phone.

Topics include:

- [Placing Calls](#)
- [Answering Calls](#)
- [Ending Calls](#)
- [Redialing Numbers](#)
- [Recent Call In Dialing](#)
- [Auto Answer](#)
- [Auto Redial](#)
- [Call Completion](#)
- [Call Return](#)
- [Call Mute](#)
- [Call Hold/Resume](#)
- [Do Not Disturb \(DND\)](#)
- [Call Forward](#)
- [Call Transfer](#)
- [Call Waiting](#)
- [Conference](#)
- [Call Park](#)
- [Call Pickup](#)
- [Anonymous Call](#)
- [Anonymous Call Rejection](#)

If you require additional information or assistance with your new phone, contact your system administrator.

Placing Calls

You can place a call in three ways using your SIP-T21P/SIP-T21 IP phone:

- Using the handset

- Using the speakerphone
- Using the headset

You can also dial the number first, and then choose the way you want to speak to the other party.



You can also search and dial a contact from call history, local directory or remote phone book. For more information, refer to [Contact Management](#) on page 27 and [Call History Management](#) on page 42.

During a call, you can alternate between Speakerphone, Headset and Handset modes by pressing the Speakerphone key, the HEADSET key, or picking up the handset.

The call duration of active call is visible on the LCD screen. In the figure below, the call to Kame has lasted 17 seconds.



To place a call using the handset:

1. Pick up the handset.
2. Enter the desired number using the keypad.
3. Press  ,  , or the **Send** soft key.

The # key is configured as a send key by default. You can also set the * key as the send key, or set neither. For more information, refer to [Key as Send](#) on page 21.







Note

You can also dial using the SIP URI or IP address. To obtain the IP address of the phone, press the **OK** key. The maximum SIP URI or IP address length is 32 characters. For example, SIP URI: 2210@sip.com, IP: 192.168.1.15.

Your phone may not support direct IP dialing. Contact your system administrator for more information.







To place a call using the hands-free speakerphone mode:

Do one of the following:

- With the handset on-hook, press  or the line key to obtain a dial tone.
Enter the desired number using the keypad.
Press  ,  , or the **Send** soft key.
- With the handset on-hook, enter the desired number using the keypad.
Press  ,  ,  , or the **Send** soft key.

To place a call using the headset:

Do one of the following:





- With the optional headset connected, press  to activate the headset mode.
Press the line key to obtain a dial tone.
Enter the desired number using the keypad.
Press , , or the **Send** soft key.
- With the optional headset connected, press  to activate the headset mode.
Enter the desired number using the keypad.
Press , , or the **Send** soft key.



Note

To permanently enable your headset, refer to [Headset Prior](#) on page 45.

To place multiple calls:

You can have more than one call on your SIP-T21P/SIP-T21 IP phone. To place a new call during an active call, do one of the following:

- Press the line key. The active call is placed on hold.
Enter the desired number using the keypad.
Press , , or the **Send** soft key.
- Press the **Hold** soft key to place the original call on hold.
Press the **NewCall** soft key.
Enter the desired number using the keypad.
Press , , or the **Send** soft key.

You can press  or  to switch between the calls, and then press the **Resume** soft key to retrieve the desired call.

Answering Calls

When you are not in another call, you can answer a call in three ways:

- Using the handset
- Using the speakerphone
- Using the headset

Note

You can ignore incoming calls by pressing the **Reject** soft key or the **Silence** soft key. You can also activate Do Not Disturb mode to ignore all incoming calls without ring on your phone. For more information, refer to [Do Not Disturb \(DND\)](#) on page 73.

You can forward incoming calls to someone else by pressing the **Fwd** soft key. For more information, refer to [Call Forward](#) on page 76.

Answering When Not in Another Call

Call duration and destination will always appear on the LCD screen for the active call.

To answer a call using the handset:

1. Pick up the handset.

To answer a call using the hands-free speakerphone mode:

Do one of the following:

- Press  .
- With the handset on-hook and headset mode deactivated, press the **Answer** soft key.
- With the handset on-hook and headset mode deactivated, press the line key (the line key LED flashes green).



To answer a call using the headset:

Do one of the following:

- Press  .
- With the headset mode activated, press the **Answer** soft key.
- With the headset mode activated, press the line key (the line key LED flashes green).

Answering When in Another Call

If you have an active call, and an incoming call arrives on the phone, do one of the following:

- Press the **Answer** soft key.
The incoming call is answered and the original call is placed on hold.
- Press  to access the new call.
Press  or the **Answer** soft key.
The incoming call is answered and the original call is placed on hold.

Ending Calls

To end a call:

Do one of the following:

- If you are using the handset, press the **Cancel** soft key or hang up the handset.
- If you are using the headset, press the **Cancel** soft key.

- If you are using the speakerphone, press  or the **Cancel** soft key.





Note To end a call placed on hold, you can press the **Cancel** soft key to end the call directly, or press the **Resume** soft key to resume the call before ending it.

Redialing Numbers

To redial the last dialed number from your phone:

1. Press  twice.
A call to your last dialed number is attempted.

To redial a previously dialed number from your phone:

1. Press  when the phone is idle.
2. Press  or  to select the desired entry, and then press  or the **Send** soft key.

Recent Call In Dialing

You can view the placed calls list when the phone is in the pre-dialing screen. To do this, you should enable recent call in dialing in advance.

To enable recent call in dialing via web user interface:

1. Click on **Directory->Setting**.
2. Select **Enabled** from the pull-down list of **Recent Call In Dialing**.

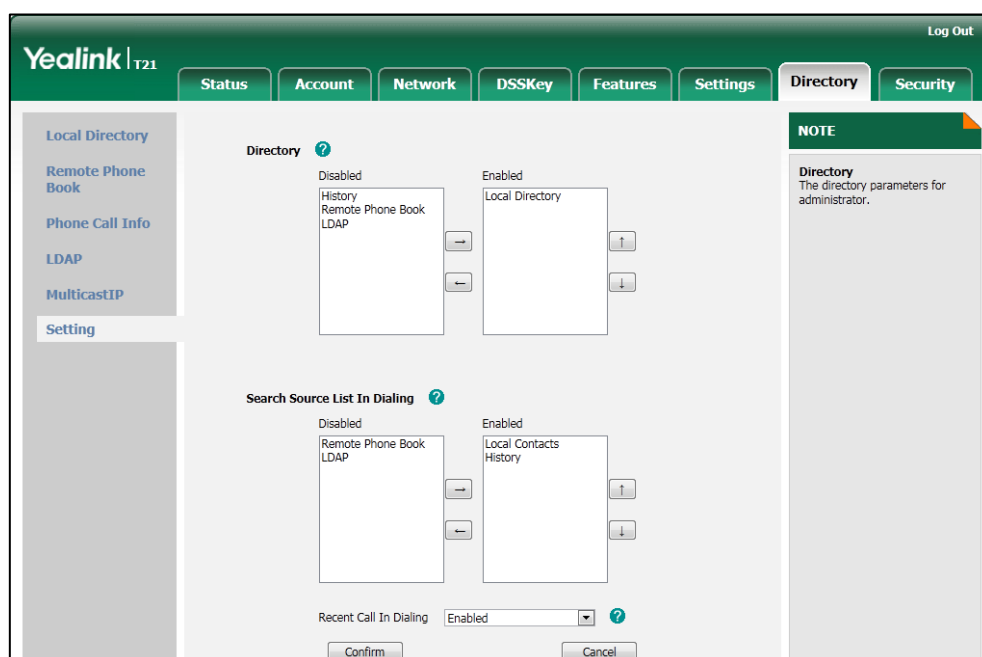



3. Click **Confirm** to accept the change.

Note

Recent call in dialing is configurable via web user interface only.

To view placed calls list when the phone is in the pre-dialing screen:

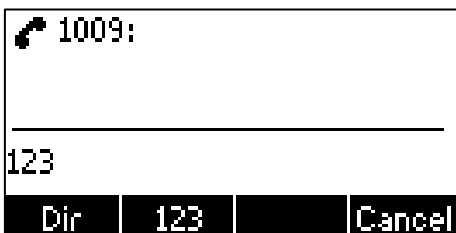

1. Pick up the handset, press the speakerphone or press the line key.
The LCD screen displays the placed calls list. You can press  or  to select the desired entry and then place a call to the contact.





Auto Answer

You can use auto answer to automatically answer an incoming call on a line. Auto answer is configurable on a per-line basis.

To configure auto answer via phone user interface:

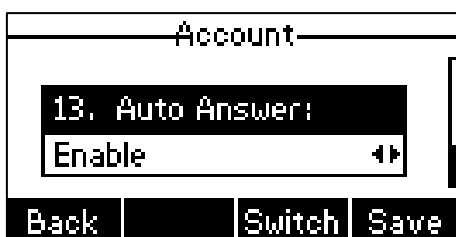
1. Press **Menu->Settings->Advanced Settings** (password: admin) ->**Accounts**.
2. Select the desired account and then press the **Enter** soft key.
3. Press  or  , or the **Switch** soft key to select **Enable** from the **Auto Answer** field.



4. Press the **Save** soft key to accept the change or the **Back** soft key to cancel.
The  icon appears on the LCD screen.

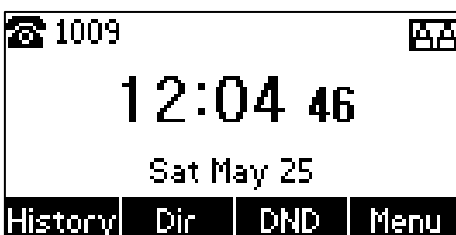

Auto answer is configurable via web user interface at the path **Account->Basic**.

Note

Auto answer is only applicable when there is no other call in progress on the phone.

Auto Redial

You can enable auto redial to redial the phone number automatically when the called party is busy. You can also configure the times settings for auto redial and the time to wait between redial attempts.

To configure auto redial via phone user interface:

1. Press **Menu->Features->Auto Redial**.
2. Press ◀ or ▶, or the **Switch** soft key to select **Enable** from the **Auto Redial** field.



3. Enter the desired time in the **Interval** field.
The default time interval is 10s.
4. Enter the desired times in the **Times** field.
The default times are 10.
5. Press the **Save** soft key to accept the change or the **Back** soft key to cancel.

Auto redial is configurable via web user interface at the path **Features->General Information**.

To use auto redial:

When the called party is busy, the following prompt will appear on the LCD screen of the phone:

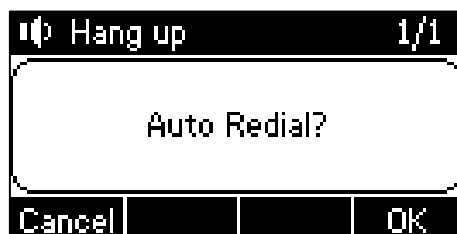

1. Press the **OK** soft key to activate auto redial.

The following prompt will appear on the LCD screen of the phone:



2. Wait for a period of time or press the **OK** soft key to redial the phone number.
The phone will retry as many times as configured until the called party is idle.

Call Completion

You can use call completion to notify the caller who failed to reach a desired callee when the callee becomes available to receive a call.

To configure call completion via phone user interface:

1. Press **Menu->Features->Call Completion**.
2. Press **◀** or **▶**, or the **Switch** soft key to select **Enable** from the **Call Completion** field.

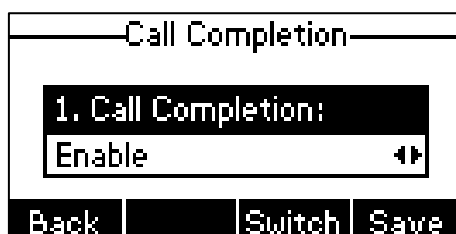

3. Press the **Save** soft key to accept the change or the **Back** soft key to cancel.

Call completion is configurable via web user interface at the path **Features->General Information**.

To use call completion:

When the called party is busy, the following prompt will appear on the LCD screen of the phone:

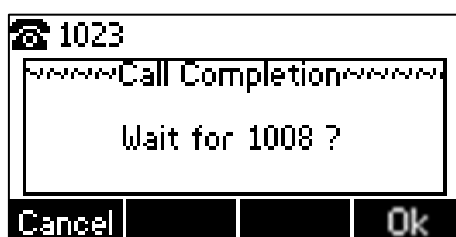

1. Press the **OK** soft key, the phone returns to the idle screen and call completion is activated.

When the called party becomes idle, the following prompt appears on the LCD screen of the phone:

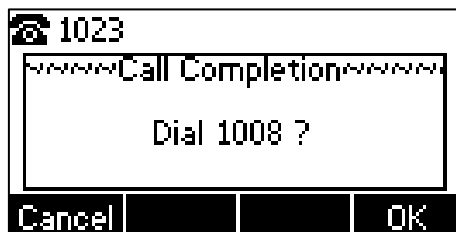

2. Press the **OK** soft key to redial the number.

Note

Call completion is not available on all servers. For more information, contact your system administrator.

Call Return

You can press a call return key to place a call back to the last incoming call.

To configure a call return key via phone user interface:

1. Press **Menu->Features->DSS Keys**.
2. Select a desired DSS key.
3. Press \leftarrow or \rightarrow , or the **Switch** soft key to select **Key Event** from the **Type** field.
4. Press \leftarrow or \rightarrow , or the **Switch** soft key to select **Call Return** from the **Key Type** field.

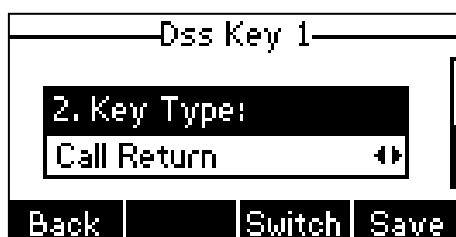

5. Press the **Save** soft key to accept the change or the **Back** soft key to cancel.

Call return key is configurable via web user interface at the path **DSSKey->Line Key**.

Call Mute

You can mute the microphone of the active audio device during an active call, and then the other party cannot hear you.

To mute a call:

1. Press \otimes during an active call.

The LCD screen indicates that the call is on mute.



To un-mute a call:

1. Press  again to un-mute the call.

Call Hold/Resume

You can place an active call on hold. Only one active call can be in progress at any time. Other calls can be made and received while placing the original call on hold. When you place a call on hold, your IP PBX may play music on hold to the other party while waiting.

To place a call on hold:

1. Press the **Hold** soft key during a call.

The line key LED flashes green. The LCD screen indicates that the call is on hold.



Note



The phone will beep softly every 30 seconds to remind you that you still have a call on hold.

To resume a held call:

1. Press the **Resume** soft key.

Multiple Calls on Hold:

If multiple calls are placed on hold, do one of the following:

- Press  or  to switch between the calls, and then press the **Resume** soft key to retrieve the desired call.
- Press the corresponding line key to retrieve the desired call.

If more than one call is placed on hold, a numbered prompt appears on the LCD screen,

for example “2/3”, indicating that this is the second call out of three calls.

Do Not Disturb (DND)

You can use DND to reject incoming calls automatically on the phone. Callers will receive a busy message.

You can enable/disable DND for the phone system, or you can customize DND for each or all accounts. Two DND modes:

- **Phone** (default): DND is effective for the phone system.
- **Custom**: DND can be configured for each or all accounts.

You can receive incoming calls from authorized numbers when DND is enabled.

To configure the DND mode via web user interface:

1. Click on **Features->Forward & DND**.
2. In the **DND** block, mark the desired radio box in the **Mode** field.

3. Click **Confirm** to accept the change.

Note

DND mode is configurable via web user interface only.

To activate DND in phone mode:

1. Press the **DND** soft key when the phone is idle.

The  icon on the idle screen indicates that DND is enabled.



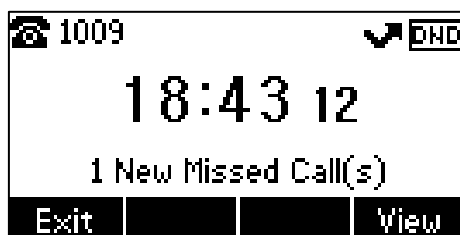

Incoming calls will be rejected automatically and "n New Missed Call(s)" ("n" indicates the number of the missed calls) will appear on the LCD screen.





To activate DND in custom mode for a specific account:

1. Press the **DND** soft key when the phone is idle.
The LCD screen displays a list of accounts on the phone.



2. Press  or  to select the desired account.
3. Press  or  soft key to select **On** to active DND.
4. Press the **Save** soft key to accept the change.

The  icon appears on the idle screen and the associated line icon changes to .

Incoming calls on this line will be rejected automatically and "n New Missed Call(s)" ("n" indicates the number of the missed calls) will appear on the LCD screen.

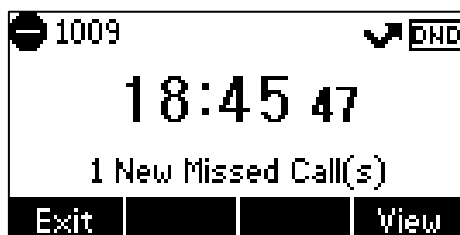

To activate DND in custom mode for all accounts:

1. Press the **DND** soft key when the phone is idle.

The LCD screen displays a list of the accounts on the phone.



2. Press the **All On** soft key to activate DND for all accounts.
3. Press the **Save** soft key to accept the change.

The DND icon appears on the idle screen and all line icons change to .

Incoming calls will be rejected automatically and "n **New Missed Call(s)**" ("n" indicates the number of the missed calls) will appear on the LCD screen.

Note

The prompt message displays only if Missed Call Log for the line is enabled. Missed Call Log is configurable via web user interface at the path **Account->Basic**.

Do Not Disturb is local to the phone, and may be overridden by the server settings. For more information, contact your system administrator.

To configure the DND authorized numbers via web user interface:

1. Click on **Features->Forward & DND**.
2. Select **Enabled** from the pull-down list of **DND Emergency**.

- Enter the numbers in the **DND Authorized Numbers** field.
For multiple numbers, enter a comma between every two numbers.

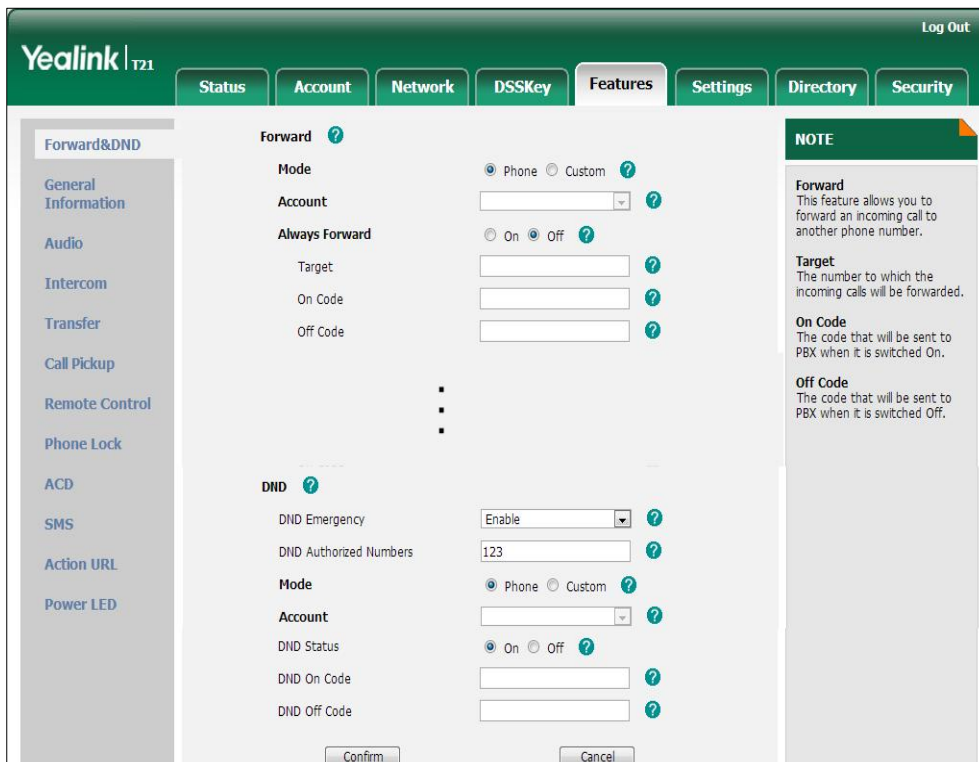

- Click **Confirm** to accept the change.
When DND is enabled on the phone, the phone can still receive incoming calls from the numbers specified in the **DND Authorized Numbers** field.

Note DND authorized number is configurable via web user interface only.

Call Forward

You can configure your phone to forward incoming calls to another party by the static forwarding. You can also forward calls while your phone is ringing, refer to the dynamic forwarding.

Static Forwarding

Three types of static forwarding:

- Always Forward:** Incoming calls are immediately forwarded.
- Busy Forward:** Incoming calls are immediately forwarded if the phone is busy.
- No Answer Forward:** Incoming calls are forwarded if not answered after a period of time.

You can enable/disable call forward for the phone system, or you can customize call

forward for each or all accounts. Two call forward modes:

- **Phone** (default): Call forward is effective for the phone system.
- **Custom**: Call forward can be configured for each or all accounts.

To configure the call forward mode via web user interface:

1. Click on **Features->Forward & DND**.
2. In the **Forward** block, mark the desired radio box in the **Mode** field.

3. Click **Confirm** to accept the change.

Note

Call forward mode is configurable via web user interface only.

To enable call forward in phone mode:

1. Press **Menu->Features->Call Forward**.
2. Press **▲** or **▼** to select the desired forwarding type, and then press the **Enter** soft key.

3. Depending on your selection:

a.) If you select **Always Forward**:

- 1) Press ◀ or ▶, or the **Switch** soft key to select **Enable** from the **Always** field.

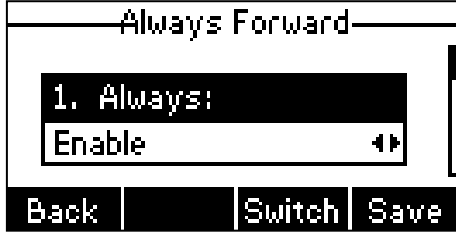

- 2) Enter the destination number you want to forward all incoming calls to in the **Forward to** field.
- 3) (Optional.) Enter the always forward on code or off code respectively in the **On Code** or **Off Code** field.

b.) If you select **Busy Forward**:

- 1) Press ◀ or ▶, or the **Switch** soft key to select **Enable** from the **Busy** field.

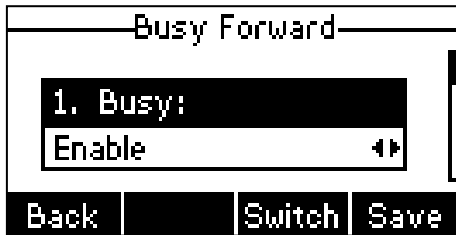

- 2) Enter the destination number you want to forward all incoming calls to when the phone is busy in the **Forward to** field.
- 3) (Optional.) Enter the busy forward on code or off code respectively in the **On Code** or **Off Code** field.

c.) If you select **No Answer Forward**:

- 1) Press ◀ or ▶, or the **Switch** soft key to select **Enable** from the **No Answer** field.

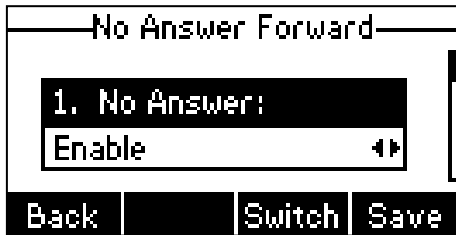

- 2) Enter the destination number you want to forward all unanswered incoming calls to in the **Forward to** field.
- 3) Press ◀ or ▶, or the **Switch** soft key to select the ring time to wait







before forwarding from the **After Ring Time** field.

The default ring time is 12 seconds.

- 4) (Optional.) Enter the no answer forward on code or off code respectively in the **On Code** or **Off Code** field.
4. Press the **Save** soft key to accept the change or the **Back** soft key to cancel.



The  icon on the idle screen indicates call forward is enabled.

To enable call forward in custom mode:

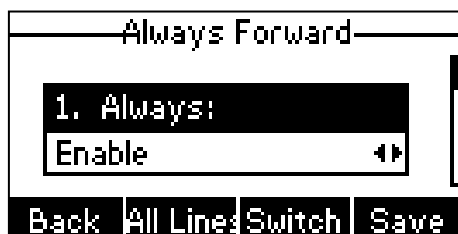
1. Press **Menu->Features->Call Forward**.
2. Press  or  to select the desired account, and then press the **Enter** soft key.
3. Press  or  to select the desired forwarding type, and then press the **Enter** soft key.
4. Depending on your selection:
 - a.) If you select **Always Forward**, you can enable it for a specific account.
 - 1) Press  or , or the **Switch** soft key to select **Enable** from the **Always** field.
 - 2) Enter the destination number you want to forward all incoming calls to in the **Forward to** field.
 - 3) (Optional.) Enter the always forward on code or off code respectively in the **On Code** or **Off Code** field.





You can also enable always forward for all accounts. After always forward was enabled for a specific account, do the following:

- 1) Press  or  to scroll to the **Always** field.
- 2) Press the **All Lines** soft key.

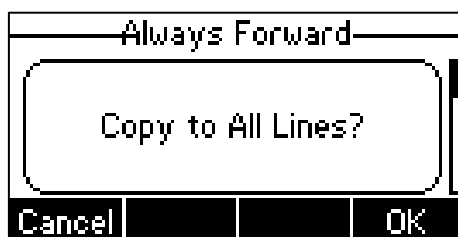
The LCD screen prompts "Copy to All Lines?".



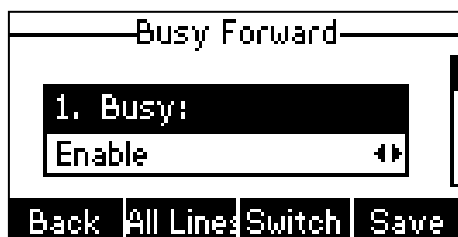

- 3) Press the **OK** soft key to accept the change or the **Cancel** soft key to cancel.

- b.) If you select **Busy Forward**, you can enable it for a specific account.
- 1) Press  or , or the **Switch** soft key to select **Enable** from the **Busy** field.
 - 2) Enter the destination number you want to forward all incoming calls to when the phone is busy in the **Forward to** field.
 - 3) (Optional.) Enter the busy forward on code or off code respectively in the **On Code** or **Off Code** field.



You can also enable busy forward for all accounts. After busy forward was enabled for a specific account, do the following:



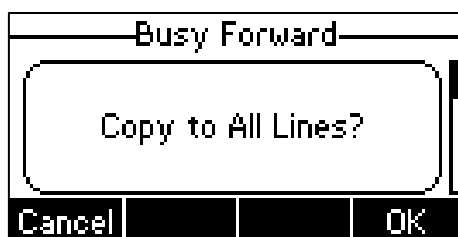

- 1) Press  or  to scroll to the **Busy** field.
- 2) Press the **All Lines** soft key.

The LCD screen prompts "Copy to All Lines?".



- 3) Press the **OK** soft key to accept the change or the **Cancel** soft key to cancel.

- c.) If you select **No Answer Forward**, you can enable it for a specific account.

- 1) Press  or , or the **Switch** soft key to select **Enable** from the **No Answer** field.
- 2) Enter the destination number you want to forward all unanswered incoming calls to in the **Forward to** field.
- 3) Press  or , or the **Switch** soft key to select the ring time to wait before forwarding from the **After Ring Time** field.

The default ring time is 12 seconds.

- 4) (Optional.) Enter the no answer forward on code or off code respectively in the **On Code** or **Off Code** field.

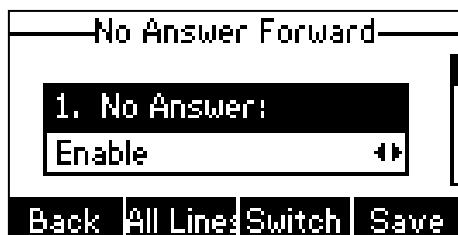

You can also enable no answer forward for all accounts. After no answer forward was enabled for a specific account, do the following:

- 1) Press or to scroll to the **No Answer** field.
- 2) Press the **All Lines** soft key.

The LCD screen prompts "Copy to All Lines?".

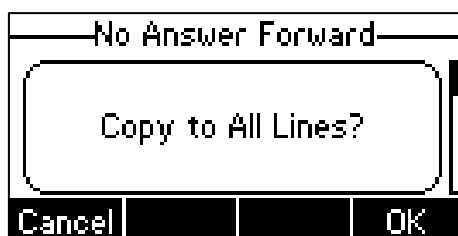

- 3) Press the **OK** soft key to accept the change or the **Cancel** soft key to cancel.
5. Press the **Save** soft key to accept the change or the **Back** soft key to cancel.

The icon appears on the idle screen and the associate line icon changes to .

Call forward is configurable via web user interface at the path **Features->Forward & DND**.

Note

You can also enter the SIP URL or IP address in the **Forward to** field. For more information on using the SIP URL or IP address, refer to [Placing Calls](#) on page 63.

Call forward is local to the phone, and may be overridden by the server settings. Call forward on code or off code may be different between servers. For more information, contact your system administrator.







To disable call forward in phone mode:

Do one of the following:

- Press when the phone is idle.
- Press **Menu->Features->Call Forward**.
Press or to select the desired forwarding type, then press the **Enter** soft key.
Press , , or the **Switch** soft key to select **Disable** to disable the call forward.

Press the **Save** soft key to accept the change.

To disable call forward in custom mode for a specific account:

1. Press **Menu->Features->Call Forward** or press  when the phone is idle.
2. Press  or  to select the desired account, then press the **Enter** soft key.
3. Press  or  to select the desired forwarding type, then press the **Enter** soft key.
4. Press ,  or the **Switch** soft key to select **Disable** to disable the call forward.
5. Press the **Save** soft key to accept the change.

Dynamic Forwarding

To forward an incoming call to another party:

1. When the phone is ringing, press the **Fwd** soft key.
2. Enter the number you want to forward the incoming call to.

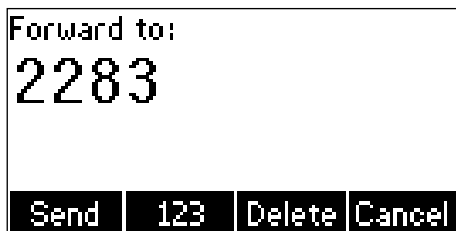

3. Press , , or the **Send** soft key.

The incoming call is forwarded. The LCD screen prompts a call forward message.

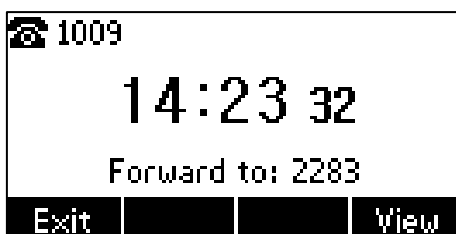



Call Transfer

You can transfer a call to another party in one of the three ways:







- **Blind Transfer:** Transfer a call directly to another party without consulting.
- **Semi-Attended Transfer:** Transfer a call when the target phone is ringing.
- **Attended Transfer:** Transfer a call with prior consulting.

To perform a blind transfer:







1. Press  or the **Tran** soft key during a call.
2. Enter the number you want to transfer the call to.

3. Press  or the **Tran** soft key to complete call transfer.
Then the call is connected to the number to which you are transferring.

To perform a semi-attended transfer:

1. Press  or the **Tran** soft key during a call.
2. Do one of the following:
 - Enter the number you want to transfer the call to.
 - Press the **Dir** soft key, and then select **Local Directory**. Select the desired group, and search for the contact (Directory should be configured in advance. Refer to [Directory](#) on page 27 for more information.).
 - Press the **Dir** soft key, and then select **History**. Select the desired list and use  or  to select the entry (Directory should be configured in advance. Refer to [Directory](#) on page 27 for more information.).
 - Press the **Dir** soft key, and then select **Remote Phone Book**. Select the desired group and search for the contact (Directory and remote phone book should be configured in advance. Refer to [Directory](#) on page 27 and [Remote Phone Book](#) on page 40 for more information.).
3. Press the **Send** soft key,  or  to dial out.
4. Press  or the **Tran** soft key to complete call transfer when receiving the ringback.

To perform an attended transfer:

1. Press  or the **Tran** soft key during a call.
2. Do one of the following:
 - Enter the number you want to transfer the call to.
 - Press the **Dir** soft key, and then select **Local Directory**. Select the desired group, and search for the contact (Directory should be configured in advance. Refer to [Directory](#) on page 27 for more information.).
 - Press the **Dir** soft key, and then select **History**. Select the desired list and use  or  to select the entry (Directory should be configured in advance. Refer to [Directory](#) on page 27 for more information.).
 - Press the **Dir** soft key, and then select **Remote Phone Book**. Select the desired group and search for the contact (Directory and remote phone book should be configured in advance. Refer to [Directory](#) on page 27 and [Remote Phone Book](#) on page 40 for more information.).
3. Press the **Send** soft key,  or  to dial out.
4. After the party answers the call, press  or the **Tran** soft key to complete call transfer.

If you are using a handset, call transfer can be completed by hanging up the handset. You can cancel call transfer before the call is connected by pressing the **Cancel** soft key.

Call Waiting

You can enable or disable call waiting on the phone. If call waiting is enabled, you can receive another call when there is an active call on the phone. Otherwise, another incoming call is automatically rejected by the phone with a busy message when there is an active call on the phone. You can also enable or disable the phone to play a warning tone when receiving another call.

To configure call waiting via phone user interface:

1. Press **Menu->Features->Call Waiting**.

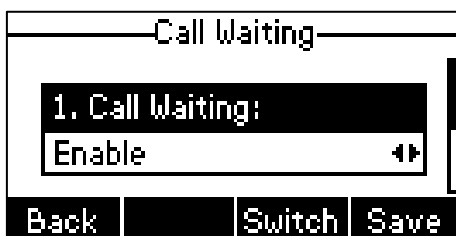

2. Press ◀ or ▶, or the **Switch** soft key to select **Enable** from the **Call Waiting** field.
3. Press ◀ or ▶, or the **Switch** soft key to select **Enable** from the **Play Tone** field.
4. (Optional.)Enter the call waiting on code or off code respectively in the **CW On Code** or **CW Off Code** field.
5. Press the **Save** soft key to accept the change or the **Back** soft key to cancel.

Call waiting is configurable via web user interface at the path **Features->General Information**.

Conference

You can create a conference with other parties using the phone's local conference. You can create a conference between an active call and a call on hold (on the same or another line) by pressing the **Conf** soft key.



Note

Network conference is not available on all servers. For more information, contact your system administrator.

Local Conference

The SIP-T21P/SIP-T21 IP phone supports up to 3 parties (including yourself) in a conference call. This is the default method of conference called Local Conference.

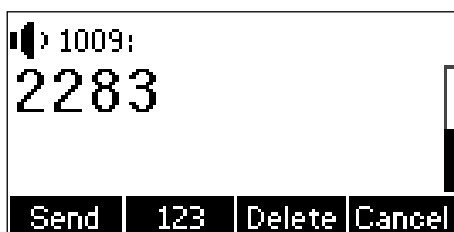

To set up a local conference call:

1. Place a call to the first party.
2. When the first party answers the call, press the **Conf** soft key to place a new call. The active call is placed on hold.
3. Enter the number of the second party and press , , or the **Send** soft key.



4. When the second party answers the call, you can consult with him or her before adding to the conference.
5. Press the **Conf** soft key again to join all parties in the conference.

To join two calls in a conference:

1. Place two calls using two different accounts on the phone (for example, place the first call using account 1, and then place the second call using account 2).
2. Press  or  to select the call for conference and make sure the call is active (for example, select the call on account 1).
3. Press the **Conf** soft key to join the two calls in the conference on the selected account.

You can press the **Hold** soft key to place the conference on hold. You can press the **Split** soft key to split the conference call into two individual calls. To drop the conference call, press the **Cancel** soft key.

Network Conference

You can use network conference on the SIP-T21P/SIP-T21 IP phone to conduct a conference with multiple participants.

This feature allows you to perform the following:

- Join two calls together into a conference call.
- Invite another party into an active conference call.

To use this feature, contact your system administrator for the network conference URI in

advance.

To configure network conference via web user interface:

1. Click on **Account**.
2. Select the desired account from the pull-down list of **Account**.
3. Click on **Advanced**.
4. Select **Network Conference** from the pull-down list of **Conference Type**.
5. Enter the conference URI (e.g., conference@example.com) in the **Conference URI** field.

The screenshot shows the Yealink T21 web interface. The top navigation bar includes 'Status', 'Account', 'Network', 'DSSKey', 'Features', 'Settings', 'Directory', and 'Security'. The 'Account' tab is active, and the 'Advanced' sub-tab is selected. The 'Account' dropdown is set to 'Account 1'. The 'Conference Type' dropdown is set to 'Network Conference', and the 'Conference URI' field contains 'conference@example.com'. Other fields include 'Keep Alive Type' (Default), 'Keep Alive Interval' (30), 'Local SIP Port' (5062), 'RPort' (Disabled), and various SIP Session Timers. A 'NOTE' box on the right states: 'Advanced: The Advanced parameters for administrator.' At the bottom, there are 'Confirm' and 'Cancel' buttons.

6. Click **Confirm** to accept the change.

To set up a network conference call:

1. Place a call to the first party.
2. Press the **Conf** soft key to place a new call.
The active call is placed on hold.
3. Enter the number of the second party and press **OK**, **#SEND**, or the **Send** soft key.
4. When the second party answers the call, press the **Conf** soft key to add the second party to the conference.
5. Press the **Conf** soft key to place a new call.
The conference is placed on hold.
6. Enter the number of the new party and then press **OK**, **#SEND**, or the **Send** soft key.
7. When the new party answers the call, press the **Conf** soft key to add the new party

to the conference.

- Repeat steps 5 to 7 until you have added all intended parties.

The procedures to set up a network conference call for specific servers may be different from introduced above. Contact your system administrator for more information.

Call Park

You can use call park to place a call on hold, and then retrieve the call from another phone in the system (for example, a phone in another office or conference room). You can park an active call by pressing the call park key on the phone. If the call is parked successfully, the response is either a voice prompt confirming that the call was parked, or a visible prompt on the LCD screen.

Note

Call park is not available on all servers. Contact your system administrator for more information.

To configure a call park key via phone user interface:

- Press **Menu->Features->DSS Keys**.
- Select the desired DSS key.
- Press \leftarrow or \rightarrow , or the **Switch** soft key to select **Key Event** from the **Type** field.
- Press \leftarrow or \rightarrow , or the **Switch** soft key to select **Call Park** from the **Key Type** field.



- Press \leftarrow or \rightarrow , or the **Switch** soft key to select the desired line from the **Account ID** field.
- Enter the call park code in the **Value** field.
- Press the **Save** soft key to accept the change or the **Back** soft key to cancel.

Call park key is configurable via web user interface at the path **DSSKey->Line Key**.

To use call park:

- User on phone A places a call to phone B.
- User on phone A wants to take the call in a conference room for privacy, then presses the call park key on phone A.
- User on phone A walks to an available conference room where the phone is designated as phone C. The user dials the call park retrieve code to retrieve the

parked call.

The system establishes call between phone C and B.

Note

The call park code and call park retrieve code are predefined on the system server. Contact your system administrator for more information.

If the parked call is not retrieved within a period of time assigned by the system, the phone performing call park feature will receive call back.

Call Pickup

You can use call pickup to answer someone else's incoming call on the phone. The SIP-T21P/SIP-T21 IP phone supports directed call pickup and group call pickup. Directed call pickup is used for picking up a call that is ringing at a specific phone number. Group call pickup is used for picking up a call that is ringing at any phone number in the group. The pickup group should be predefined, contact your system administrator for more information.

You can pick up an incoming call by using the **DPickup/GPickup** soft key. To use call pickup, you need to configure the call pickup code beforehand on a global or per-line basis via web user interface.

Note

If there are many incoming calls at the same time, pressing the **GPickup** soft key on the phone will pick up the call that rings first.

Directed Call Pickup

To enable the directed call pickup via web user interface:

1. Click on **Features->Call Pickup**.

2. Select **Enabled** from the pull-down list of **Directed Call Pickup**.

The screenshot shows the 'Call Pickup' configuration page in the Yealink T21 web interface. The 'Features' tab is selected. The 'Call Pickup' section has the following settings:

- Directed Call Pickup: Enabled
- Directed Call Pickup Code: (empty field)
- Group Call Pickup: Disabled
- Group Call Pickup Code: (empty field)
- Visual Alert for BLF Pickup: Disabled
- Audio Alert for BLF Pickup: Disabled

Buttons for 'Confirm' and 'Cancel' are visible at the bottom. A 'NOTE' box on the right contains the text: 'Call Pickup: The call pickup parameters for administrator.'

3. Click **Confirm** to accept the change.

To configure the directed call pickup code on a global basis via web user interface:

1. Click on **Features->Call Pickup**.
2. Enter the directed call pickup code in the **Directed Call Pickup Code** field.

This screenshot is identical to the previous one, but the 'Directed Call Pickup Code' field now contains the value '*97'.

3. Click **Confirm** to accept the change.

To configure the directed call pickup code on a per-line basis via web user interface:

1. Click on **Account**.
2. Select the desired account from the pull-down list of **Account**.
3. Click on **Advanced**.

- Enter the directed call pickup code in the **Directed Call Pickup Code** field.

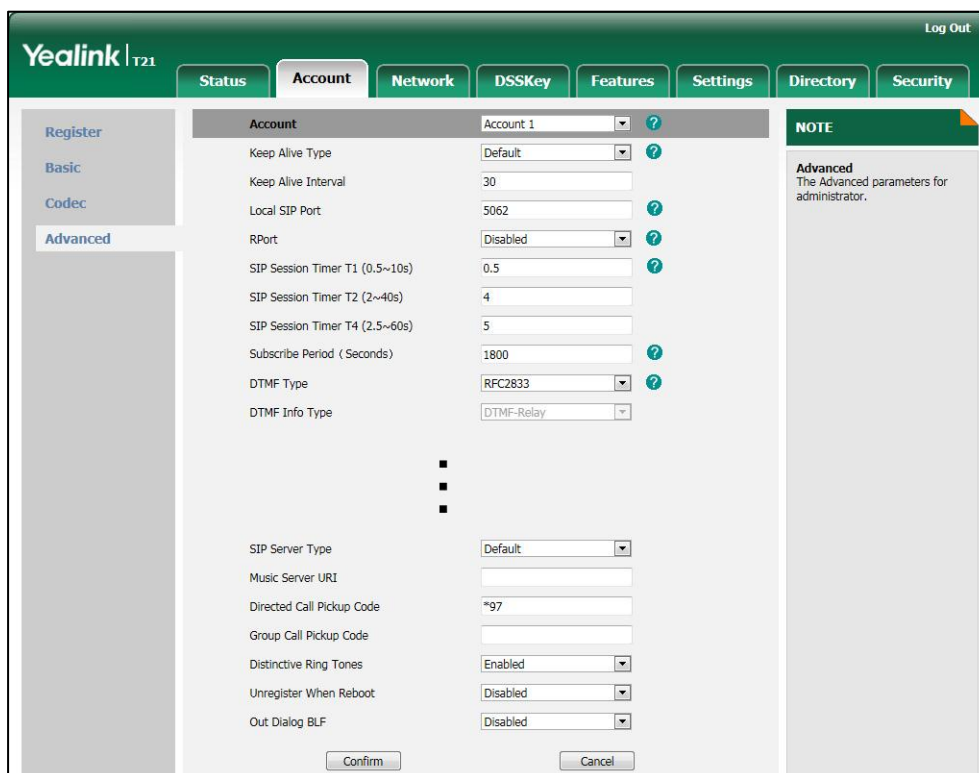

- Click **Confirm** to accept the change.

To pick up a call directly:

- Pick up the handset.

The **DPickup** soft key appears on the LCD screen.



- Press the **DPickup** soft key on your phone when a phone receives an incoming call.
- Enter the phone number which receives an incoming call.
- Press the **DPickup** soft key again.

The call is answered on your phone.

You can also configure a DSS key as directed pickup key via phone user interface or web user interface. You can pick up a call by pressing the directed pickup key directly.

Group Call Pickup

To enable the group call pickup via web user interface:

1. Click on **Features**->**Call Pickup**.
2. Select **Enabled** from the pull-down list of **Group Call Pickup**.

The screenshot shows the Yealink T21 web interface. The 'Features' tab is selected, and the 'Call Pickup' sub-tab is active. The configuration table is as follows:

Feature	Value	Help
Directed Call Pickup	Disabled	?
Directed Call Pickup Code		?
Group Call Pickup	Enabled	?
Group Call Pickup Code		?
Visual Alert for BLF Pickup	Disabled	?
Audio Alert for BLF Pickup	Disabled	?

Buttons: Confirm, Cancel

NOTE
Call Pickup
The call pickup parameters for administrator.

3. Click **Confirm** to accept the change.

To configure the group call pickup code on a global basis via web user interface:

1. Click on **Features**->**Call Pickup**.
2. Enter the group call pickup code in the **Group Call Pickup Code** field.

The screenshot shows the Yealink T21 web interface. The 'Features' tab is selected, and the 'Call Pickup' sub-tab is active. The configuration table is as follows:

Feature	Value	Help
Directed Call Pickup	Disabled	?
Directed Call Pickup Code		?
Group Call Pickup	Enabled	?
Group Call Pickup Code	*98	?
Visual Alert for BLF Pickup	Disabled	?
Audio Alert for BLF Pickup	Disabled	?

Buttons: Confirm, Cancel

NOTE
Call Pickup
The call pickup parameters for administrator.

3. Click **Confirm** to accept the change.

To configure the group call pickup code on a per-line basis via web user interface:

1. Click on **Account**.
2. Select the desired account from the pull-down list of **Account**.
3. Click on **Advanced**.
4. Enter the group call pickup code in the **Group Call Pickup Code** field.

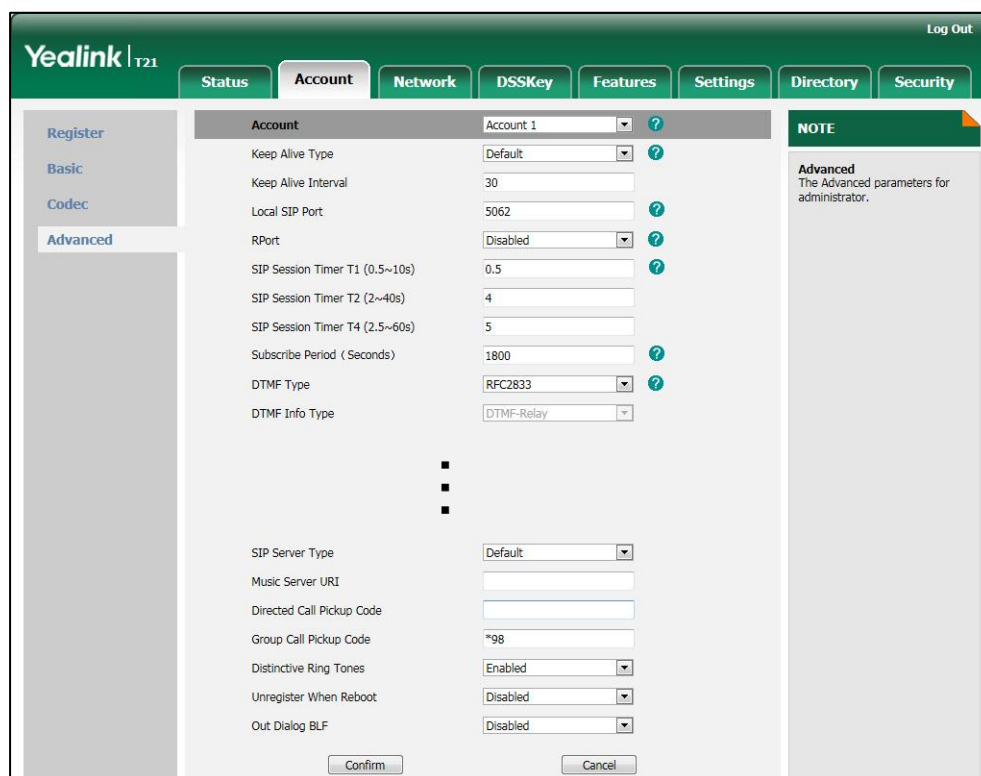

5. Click **Confirm** to accept the change.

To pick up a call in the group:

1. Pick up the handset.

The **GPickup** soft key appears on the LCD screen.



2. Press the **GPickup** soft key on your phone when a phone in the group receives an incoming call.

The call is answered on your phone.

You can also configure a DSS key as a group pickup key via phone user interface or web user interface. You can pick up a call by pressing the group pickup key directly.

Note

The directed call pickup code and group call pickup code are predefined on the system server. Contact your system administrator for more information.

The call pickup code configured on a per-line basis takes precedence over that configured on a global basis.

Anonymous Call

You can use anonymous call to block the identity and phone number from showing up to the called party when you call someone. For example, you want to call to consult some of the services, but don't want to be harassed. Anonymous call is configurable on a per-line basis. You can also configure the phone to send anonymous on/off code to the server to activate/deactivate anonymous call on the server side.

Note

Anonymous call is not available on all servers. Contact your system administrator for the anonymous call on code and off code.

To configure anonymous call via phone user interface:

1. Press **Menu->Features->Anonymous Call**.
2. Press \leftarrow or \rightarrow , or the **Switch** soft key to select the desired line from the **Line ID** field.
3. Press \leftarrow or \rightarrow to select **Enable** from the **Send Anonymous** field.

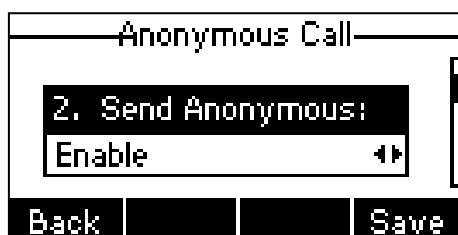

4. (Optional.) Press \leftarrow or \rightarrow to select the desired value from the **Anonymous Code** field.
5. (Optional.) Enter the anonymous call on code in the **Call On Code** field.
6. (Optional.) Enter the anonymous call off code in the **Call Off Code** field.
7. Press the **Save** soft key to accept the change or the **Back** soft key to cancel.

Anonymous call is configurable via web user interface at the path **Account->Basic**.

To place an anonymous call:

- Using the specific line on the phone to place a call to phone B.
The LCD screen of phone B prompts an incoming call from anonymity.

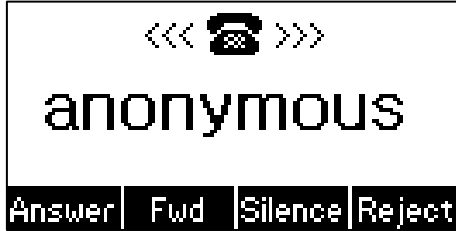

Anonymous Call Rejection

You can use anonymous call rejection to reject incoming calls from anonymous callers. Anonymous call rejection automatically rejects incoming calls from callers who deliberately block their identities and numbers from showing up. Anonymous call rejection is configurable on a per-line basis.

To configure anonymous call rejection via phone user interface:

- Press **Menu->Features->Anonymous Call**.
- Press \leftarrow or \rightarrow , or the **Switch** soft key to select the desired line from the **Line ID** field.
- Press \uparrow or \downarrow to scroll to the **Rejection** field.
- Press \leftarrow or \rightarrow , or the **Switch** soft key to select **Enable** from the **Rejection** field.

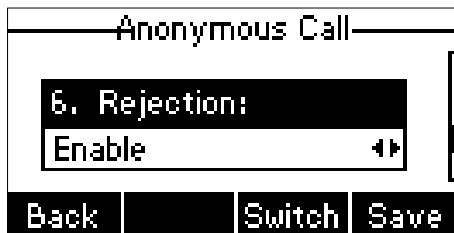

- (Optional.) Enter the anonymous call rejection on code in the **Reject On Code** field.
- (Optional.) Enter the anonymous call rejection off code in the **Reject Off Code** field.
- Press the **Save** soft key to accept the change or the **Back** soft key to cancel.

Anonymous call rejection is configurable via web user interface at the path **Account->Basic**.

Advanced Phone Features

This chapter provides operating instructions for the advanced features of the SIP-T21P/SIP-T21 IP phone. Topics include:

- [Busy Lamp Field \(BLF\)](#)
- [Call Recording](#)
- [Hot Desking](#)
- [Intercom](#)
- [Multicast Paging](#)
- [Music on Hold](#)
- [Automatic Call Distribution \(ACD\)](#)
- [Messages](#)



If you require additional information or assistance with your new phone, contact your system administrator.

Busy Lamp Field (BLF)



You can use BLF to monitor a specific line for status changes on the phone. For example, you can configure a BLF key on the phone for monitoring the status of a friend's line (busy or idle). The BLF key LED illuminates solid green when the friend's line is in use. For more information on BLF key LED indications, refer to [LED Instructions](#) on page 4.

You can press a BLF key to dial out the monitored phone number when the monitored line is idle. You can receive a visual and an audio alert (if enabled), and also pick up the call when the monitored line receives an incoming call. For more information, contact your system administrator.

To configure a BLF key via phone user interface:

1. Press **Menu->Features->DSS Keys**.
2. Select the desired DSS key.
3. Press  or , or the **Switch** soft key to select **BLF** from the **Type** field.



4. Press  or  , or the **Switch** soft key to select the desired line from the **Account ID** field.
5. Enter the phone number or extension you want to monitor in the **Value** field.
6. (Optional.) Enter the pickup code in the **Extension** field.
7. Press the **Save** soft key to accept the change or the **Back** soft key to cancel.

BLF key is configurable via web user interface at the path **DSSKey->Line Key**.

You can enable audio alert for BLF pickup feature on the phone. This allows the monitoring phone to play a warning tone when the monitored line receives an incoming call. You can also enable visual alert for BLF pickup feature on the phone. This allows the LCD screen of the monitoring phone to display the caller ID when the monitored line receives an incoming call.

To enable visual and audio alert features via web user interface:

1. Click on **Features->Call Pickup**.
2. Select **Enabled** from the pull-down list of **Visual Alert for BLF Pickup**.
3. Select **Enabled** from the pull-down list of **Audio Alert for BLF Pickup**.

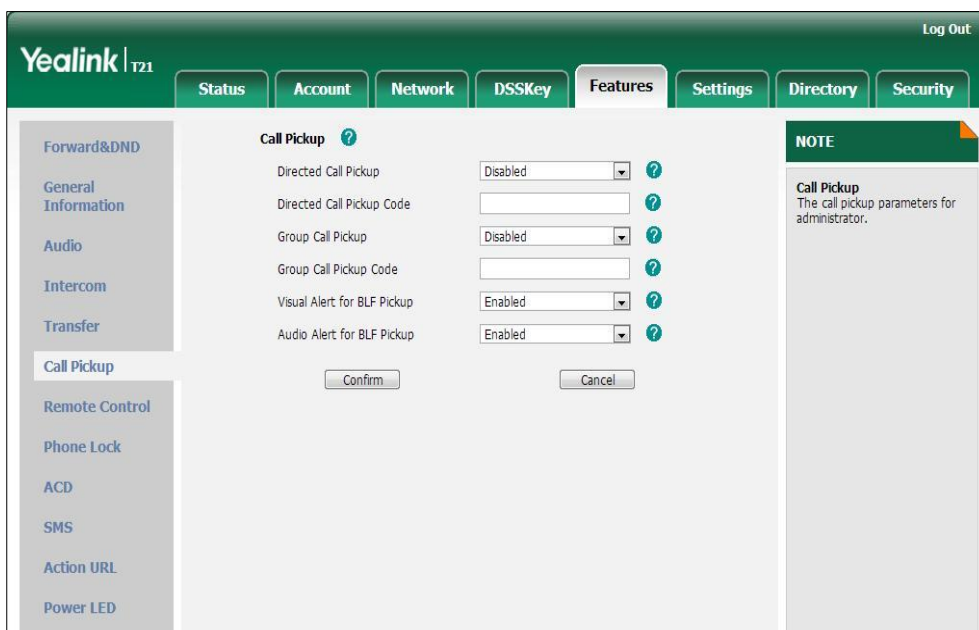

4. Click **Confirm** to accept the change.

Note Visual and audio alert features are configurable via web user interface only.

When the monitored line receives an incoming call, the followings occur on the phone:

- The phone plays a warning tone (if enabled).
- The BLF key LED flashes green.
- The caller ID appears on the LCD screen (if enabled).

In the following figure, the LCD screen shows an incoming call from 2020 on the monitored line.



Note

If your phone is locked and the type of the keypad lock is configured as **Function key** or **All Keys**, you cannot use the **Pickup**, **Send**, **NewCall** and **Cancel** soft keys until unlocked.

When there is an active call on the IP phone, you can transfer the active call to the monitored phone number directly by pressing the BLF key. The phone transfers the active call differently depending on the transfer mode on DSS key. For more information on the transfer mode on DSS key, refer to transfer in the [DSS Keys](#) section on page 46.

Call Recording

You can record calls by pressing a record key on the phone. The SIP-T21P/SIP-T21 IP phone supports record and URL record.



Two ways of call recording:

- **Record:** The phone sends SIP INFO message containing a specific header "Record: on/off" to trigger a recording.
- **URL Record:** The phone sends HTTP URL request to trigger a recording. Contact your system administrator for the predefined URL.

Note

Call record is not available on all servers. Contact your system administrator for more information.

To configure a record key via phone user interface:

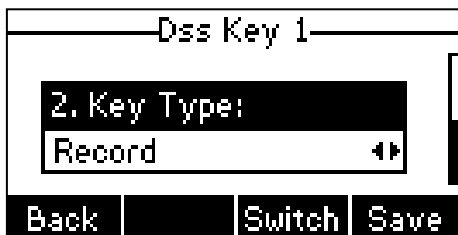

1. Press **Menu->Features->DSS Keys**.
2. Select the desired DSS key.
3. Press  or , or the **Switch** soft key to select **Key Event** from the **Type** field.

4. Press  or , or the **Switch** soft key to select **Record** from the **Key Type** field.



5. Press the **Save** soft key to accept the change or the **Back** soft key to cancel.

To configure a URL record key via phone user interface:

1. Press **Menu->Features->DSS Keys**.
2. Select the desired DSS key.
3. Press  or , or the **Switch** soft key to select **URL Record** from the **Type** field.



4. Enter the URL (e.g., <http://10.1.2.224/phonerecording.cgi>) in the **Value** field.
5. Press the **Save** soft key to accept the change or the **Back** soft key to cancel.

Record and URL record keys are configurable via web user interface at the path **DSSKey->Line Key**.

The record and URL record keys control the recording, and are available:

- During an active call
- When calls are on hold or mute
- During a blind or attended transfer
- During a conference call
- When the phone prompts you to answer an incoming call

The record and URL record keys are not available when:

- There are no connected calls on your phone
- You place a new call

To record a call:

1. Press a record or a URL record key during a call.
If the recording starts successfully, the recording icon will appear on the LCD screen and the record or URL record key LED will flash green.

2. Press the record or URL record key again to stop recording.

The recording icon disappears from the LCD screen and the record or URL record key LED goes out.

Recording status indications you need to know:

Circumstance	Icons on the LCD screen
A recording is started	● appears on the LCD screen
A recording cannot be started	⊗ appears for 1 second
A recording cannot be stopped	⊘ appears for 1 second, then goes back
The recording box is full	⊔ appears for 1 second
The call cannot be recorded	⊗ appears for 1 second

You can listen to the recordings stored on your server system. For example, you can dial an access code to listen to the recordings.

Note

The way in which you listen to the recordings may be different on different servers. Contact your system administrator for more information.

Hot Desking



Hot desking originates from the definition of being the temporary physical occupant of a work station or surface by a particular employee. A primary motivation for hot desking is cost reduction. This feature is regularly used in places where not all the employees are in the office at the same time, or not in the office for very long at all, which means actual personal offices would be often vacant, consuming valuable space and resources.



You can use hot desking on the SIP-T21P/SIP-T21 IP phone to log out of the existing accounts and then log into a new account, that is, many users can share the phone resource in different time. To use this feature, you need to configure a hot desking key in advance.

Note

Hot desking is not available on all servers. Contact your system administrator for more information.

To configure a hot desking key via phone user interface:

1. Press **Menu->Features->DSS Keys**.
2. Select the desired DSS key.
3. Press  or , or the **Switch** soft key to select **Key Event** from the **Type** field.

4. Press  or , or the **Switch** soft key to select **Hot Desking** from the **Key Type** field.

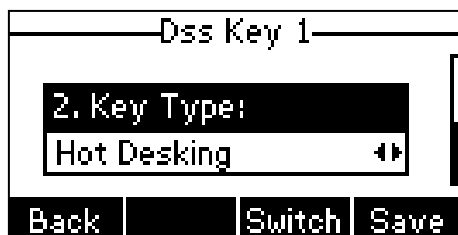

5. Press the **Save** soft key to accept the change or the **Back** soft key to cancel.

Hot desking key is configurable via web user interface at the path **DSSKey->Line Key**.

To use hot desking:

1. Press the hot desking key when the phone is idle.
The LCD screen prompts "Clear all account config?".

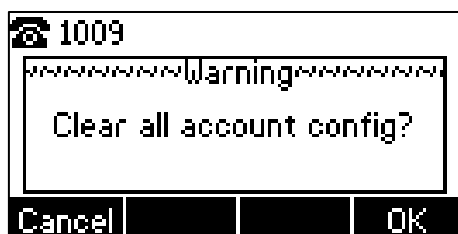

2. Press the **OK** soft key, registration configurations (e.g., display name, register name, user name and password) of all accounts will be cleared immediately.

The login wizard will be shown as below:



3. Enter the desired values in the **User Name** and **Password** respectively. Contact your system administrator for more information.
4. Press the **Save** soft key to login or **Cancel** soft key to cancel.

Intercom

Intercom is a useful feature in an office environment to quickly connect with the operator or the secretary. You can press the intercom key to automatically connect with a remote extension for outgoing intercom calls, and the remote extension will automatically answer the incoming intercom calls.

Note

Intercom is not available on all servers. Contact your system administrator for more information.

Outgoing Intercom Calls

To configure an intercom key via phone user interface:

1. Press **Menu->Features->DSS Keys**.
2. Select the desired DSS key.
3. Press **◀** or **▶**, or the **Switch** soft key to select **Intercom** from the **Type** field.



4. Select the desired line from the **Account ID** field.
5. Enter the remote extension number in the **Value** field.
6. Press the **Save** soft key to accept the change or the **Back** soft key to cancel.

Intercom key is configurable via web user interface at the path **DSSKey->Line key**.

To place an intercom call:

1. Press the intercom key when the phone is idle.
The phone is automatically connected to the extension specified in the **Value** field.
2. Press the intercom key again or the **Cancel** soft key to end the intercom call.

Incoming Intercom Calls



The SIP-T21P/SIP-T21 IP phone supports automatically to answer an incoming intercom call by default. The phone automatically plays a warning tone when it receives an incoming intercom call. In addition, you can enable the phone to mute the microphone when it automatically answers an incoming intercom call. You can also enable the

phone to automatically answer an incoming intercom call while there is already an active call on the phone, the active call is placed on hold.

Intercom features you need to know:

Intercom Feature	Description
Accept Intercom	Enable or disable the IP phone to automatically answer an incoming intercom call.
Intercom Mute	Enable or disable the microphone on the IP phone for intercom calls.
Intercom Tone	Enable or disable the IP phone to play a warning tone when it receives an incoming intercom call.
Intercom Barge	Enable or disable the IP phone to automatically answer an incoming intercom call while there is already an active call on the phone.

To configure intercom features via phone user interface:

1. Press **Menu->Features->Intercom**.
2. Make the desired changes (Press  or  to switch between different intercom features).



3. Press the **Save** soft key to accept the change or the **Back** soft key to cancel.

These specific parameters are configurable via web user interface at the path **Features->Intercom**.

Accept Intercom

You can enable or disable the phone to automatically answer an incoming intercom call. If Accept Intercom is enabled, the phone automatically answers an incoming intercom call. If Accept Intercom is disabled, the phone rejects incoming intercom calls and sends a busy message to the caller. Accept Intercom is enabled by default.

Note

Your administrator can set a delay time before the phone automatically answers intercom calls. Contact your system administrator for more information.

Intercom Mute

You can mute or un-mute the microphone on the phone for intercom calls automatically. If Intercom Mute is enabled, the microphone is muted for intercom calls. If Intercom

Mute is disabled, the microphone works for intercom calls. Intercom Mute is disabled by default.

Intercom Tone

You can enable or disable the phone to play a warning tone when receiving an intercom call. If Intercom Tone is enabled, the phone plays a warning tone before answering the intercom call. If Intercom Tone is disabled, the phone automatically answers the intercom call without warning. Intercom Tone is enabled by default.

Intercom Barge





You can enable or disable the phone to automatically answer an incoming intercom call while there is already an active call on the phone. If Intercom Barge is enabled, the phone automatically answers the intercom call and places the active call on hold. If Intercom Barge is disabled, the phone handles an incoming intercom call like a waiting call. Intercom Barge is disabled by default.

Multicast Paging

You can use multicast paging to quickly and easily forward time sensitive announcements out to people within the multicast group. You can configure a multicast paging key on the phone, which allows you to send a Real Time Transport Protocol (RTP) stream to the pre-configured multicast address(es) without involving SIP signaling. You can configure the phone to receive an RTP stream from pre-configured multicast listening address(es) without involving SIP signaling. You can specify up to 10 multicast listening addresses.

Sending RTP Stream

To configure a multicast paging key via phone user interface:

1. Press **Menu->Features->DSS Keys**.
2. Select the desired DSS key.
3. Press  or , or the **Switch** soft key to select **Key Event** from the **Type** field.
4. Press  or , or the **Switch** soft key to select **Multicast Paging** from the **Key Type** field.

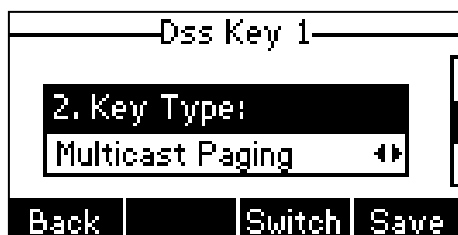

5. Enter the multicast IP address and port (e.g., 224.5.6.20:10008) in the **Value** field.

The valid multicast IP addresses range from 224.0.0.0 to 239.255.255.255.

6. Press the **Save** soft key to accept the change or the **Back** soft key to cancel.

Multicast paging key is configurable via web user interface at the path **DSSKey->Line Key**.

You can also configure the phone to use a default codec for sending multicast RTP stream via web interface.

To configure a default codec for multicast paging via web user interface:

1. Click on **Features->General Information**.
2. Select the desired codec from the pull-down list of **Multicast Codec**.

The default codec is *G722*.

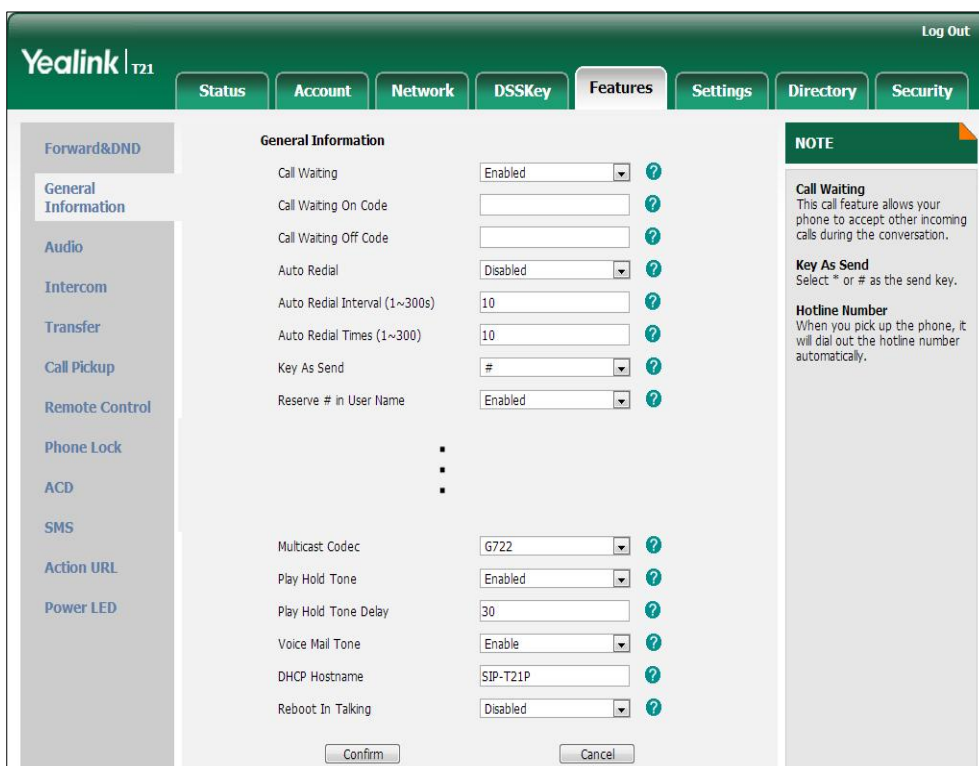

3. Click **Confirm** to accept the change.

Note If G722 codec is used for multicast paging, the LCD screen prompts "HD" to indicate that the phone is providing high definition voice.
Default codec for multicast paging is configurable via web user interface only.

To send RTP stream:

1. Press the multicast paging key when the phone is idle.

The phone sends RTP to a preconfigured multicast address (IP: Port). Any phone in the local network then listens to the RTP on the preconfigured multicast address (IP: Port). For both sending and receiving of the multicast RTP, there is no SIP signaling

involved.

The multicast paging key LED illuminates solid green.

The following figure shows a multicast RTP session on the phone:



2. Press the **Hold** soft key to place the current multicast RTP session on hold.
3. Press the **Cancel** soft key to cancel the multicast RTP session.

Note

Multicast RTP is one way only from sender to the multicast address(es) (receiver). For outgoing RTP multicasts, all other existing calls on the phone will be placed on hold.

Receiving RTP Stream

You can configure the phone to receive a Real Time Transport Protocol (RTP) stream from the pre-configured multicast address(es) without involving SIP signaling. You can specify up to 10 multicast addresses that the phone listens to on the network.

How the phone handles incoming multicast paging calls depends on Paging Barge and Paging Priority Active parameters configured via web user interface.

Paging Barge

Paging barge parameter defines the priority of the voice call in progress. If the priority of an incoming multicast paging call is lower than that of the active call, it will be ignored automatically. If Disabled is selected from the pull-down list of Paging Barge, the voice call in progress takes precedence over all incoming multicast paging calls. Valid values in the Paging Barge field:

- **1 to 10:** Define the priority of an active call, 1 with the highest priority, 10 with the lowest.
- **Disabled:** The voice call in progress shall take precedence over all incoming paging calls.

Paging Priority Active

Paging priority active parameter decides how the phone handles the incoming multicast paging calls when there is already a multicast paging call on the phone. If enabled, the phone will ignore incoming multicast paging calls with lower priorities, otherwise, the phone will answer incoming multicast paging calls automatically and place the previous multicast paging call on hold. If disabled, the phone will automatically ignore all incoming multicast paging calls.

To configure multicast listening addresses via web user interface:

1. Click on **Directory**->**MulticastIP**.
2. Select the desired value from the pull-down list of **Paging Barge**.
3. Select the desired value from the pull-down list of **Paging Priority Active**.
4. Enter the multicast IP address(es) and port number (e.g., 224.5.6.20:10008) which the phone listens for incoming RTP multicast in the **Listening Address** field.

The valid multicast IP addresses range from 224.0.0.0 to 239.255.255.255.

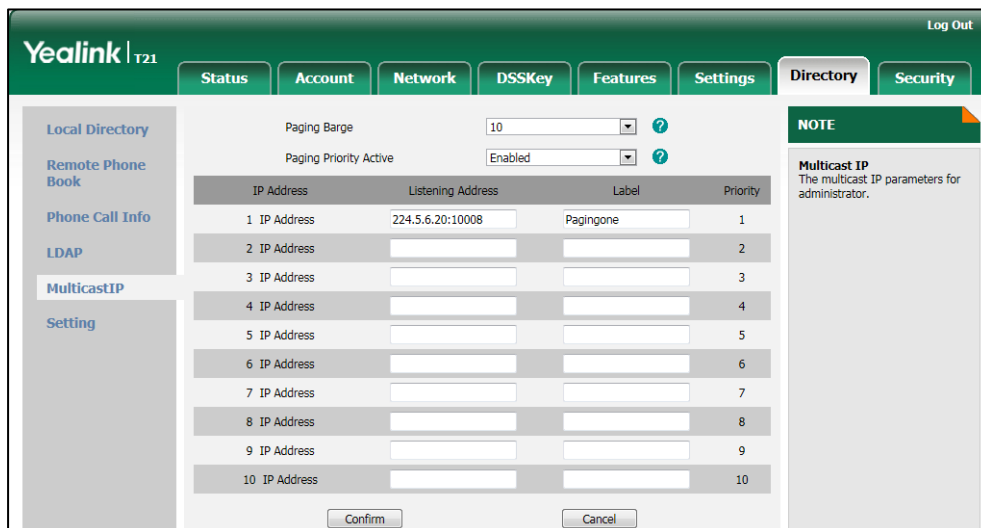

5. Enter the label in the **Label** field.
Label will appear on the LCD screen when receiving the RTP multicast.
6. Click **Confirm** to accept the change.

Note The priorities of listening addresses are predefined: 1 with the highest priority, 10 with the lowest.

Both the multicast paging sender and the receiver play a warning tone when pressing the multicast paging key.

Multicast listening addresses is configurable via web user interface only.

Music on Hold

Music on hold (MoH) is the business practice of playing recorded music to fill the silence that would be heard by the party placed on hold. To use this feature, you should specify a SIP URI pointing to a MoH server account. When a call is placed on hold, the phone will send a SIP INVITE message to the MoH server account. The MoH server account automatically answers to the SIP INVITE messages and immediately plays audio from some source located anywhere (LAN, Internet) to the held party. Contact your system administrator for the SIP URI.

To configure MoH server via web user interface:

1. Click on **Account**.
2. Select the desired account from the pull-down list of **Account**.
3. Click on **Advanced**.
4. Enter the SIP URI (e.g., sip:moh@sip.com) in the **Music Server URI** field.

The screenshot shows the Yealink T21 web user interface. The top navigation bar includes 'Status', 'Account', 'Network', 'DSSKey', 'Features', 'Settings', 'Directory', and 'Security'. The 'Account' tab is active, and the 'Advanced' sub-tab is selected. The 'Account' dropdown menu is set to 'Account 1'. The configuration fields are as follows:

Field	Value
Keep Alive Type	Default
Keep Alive Interval	30
Local SIP Port	5062
RPort	Disabled
SIP Session Timer T1 (0.5~10s)	0.5
SIP Session Timer T2 (2~40s)	4
SIP Session Timer T4 (2.5~60s)	5
Subscribe Period (Seconds)	1800
ACD Subscrip Period(120~3600s)	3600
Early Media	Disabled
SIP Server Type	Default
Music Server URI	moh@sip.com
Directed Call Pickup Code	
Group Call Pickup Code	
Distinctive Ring Tones	Enabled
Unregister When Reboot	Disabled
Out Dialog BLF	Disabled

At the bottom of the form, there are 'Confirm' and 'Cancel' buttons. A 'NOTE' box on the right side of the page states: 'Advanced: The Advanced parameters for administrator.'

5. Click **Confirm** to accept the change.

When you have placed a call on hold, the held party can hear the music.

Note

All involved parties cannot use encrypted RTP (SRTP).
MoH server is configurable via web user interface only.



Automatic Call Distribution (ACD)

ACD is often used in offices for customer service, such as call center. The ACD system handles large volumes of incoming calls from callers who have no need to talk to a specific person but who require assistance from any of multiple persons at the earliest opportunity. ACD on the SIP-T21P/SIP-T21 IP phone allows the ACD system to distribute large volumes of incoming calls to the registered ACD users. To use this feature, you should configure an ACD key in advance.

Note

Make sure ACD is enabled on your IP phone. For more information on enabling ACD, contact your system administrator.

To configure an ACD key via phone user interface:

1. Press **Menu->Features->DSS Keys**.
2. Select the desired DSS key.
3. Press  or , or the **Switch** soft key to select **ACD** from the **Type** field.

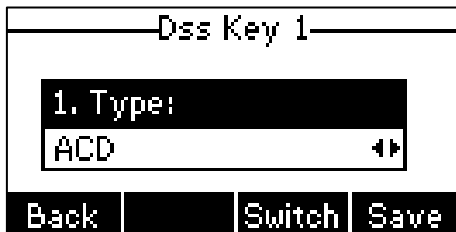

4. Press the **Save** soft key to accept the change or the **Back** soft key to cancel.

ACD key is configurable via web user interface at the path **DSSKey->Line Key**.

To log into the ACD system:

1. Press the ACD key when the phone is idle.

The LCD screen prompts you the following information:

User ID: the identity used to log into the queue.

Password: the password used to log into the queue.

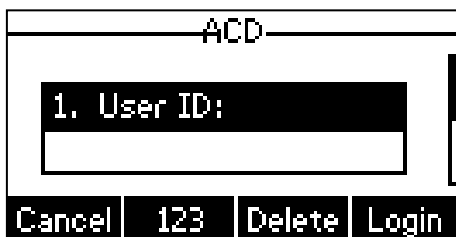

2. Press the **Login** soft key to login.

Note

Contact your system administrator for the User ID and Password to access the ACD system.

After configuring an ACD key, you can press the ACD key to log into the ACD system. After logging in, you are ready to receive calls from the ACD system. You can press the ACD key to show your current ACD user status. You can press the **Available/Unavailable** soft key to change your ACD user status. ACD user status synchronizes on both IP phone and ACD system. When you set the ACD user status to be available, the ACD key LED illuminates solid green, and then the server begins distributing calls to your phone. When you set the phone to be unavailable, the ACD key LED flashes green, and then the server temporarily stops distributing calls to your phone. To log out of the ACD system, press the **Logout** soft key.

Note

It is recommended you configure no more than one ACD key per phone. At any time, at most one ACD key can be in progress on your phone.

Messages

Short Message Service (SMS)

You can send and receive text messages using the SIP-T21P/SIP-T21 IP phone. New text messages can be indicated both acoustically and visually. When receiving a new text message, the phone will play a warning tone. The LCD screen will prompt receiving new text messages with the number of waiting messages (e.g., 1 New Text Message(s)) and a flashing icon.



You can store text messages in your phone's Inbox, Sentbox, Outbox or Draftbox. Each of the boxes can store up to 100 text messages. If the number of the text messages in one box is more than 100, the phone will directly delete the oldest text message in the box.

Note SMS is not available on all servers. Contact your system administrator for more information.

To read a text message:

1. Press **Menu->Messages->Text Message->Inbox**.



2. Select the desired message and press the **View** soft key.

Note If the phone prompts receiving new text messages, you can also press the **View** soft key to read the new messages directly.

To send a text message:

1. Press **Menu->Messages->Text Message->New Message**.

2. Compose the new text message. You can press the **abc** soft key to change the input mode.



3. Press the **Send** soft key after completing the content.
4. (Optional.) Press ◀ or ▶, or the **Switch** soft key to select the desired account from the **From** field.
5. Enter the number you want to send the message to in the **To** field.
6. Press the **Send** soft key to send the message or the **Back** soft key to cancel.

Sending a text message is configurable via web user interface at the path **Features>SMS**.

To reply a text message:

1. Press **Menu->Messages->Text Message->Inbox**.
2. Select the desired message and press the **Reply** soft key.



3. Compose the new text message. You can press the **abc** soft key to change the input mode.
4. Press the **Send** soft key after completing the content.

To delete a text message:

1. Press **Menu->Messages->Text Message->Inbox (sentbox, Outbox or Draftbox)**.
2. Select the desired message and then press the **Delete** soft key.



3. Select **Delete** to delete the desired message.

The LCD screen prompts “Delete Message?”.



4. Press the **OK** soft key to delete this message or the **Cancel** soft key to cancel.

You can also delete all text messages by pressing the **Delete** soft key and then select **Del All**. For more information, refer to the above steps.

Note You can also delete a specific message after retrieving by pressing the **Delete** soft key.

Voice Mail

You can leave voice mails for someone else on the SIP-T21P/SIP-T21 IP phone. You can also listen to the voice mails stored in a centralized location. When receiving a new voice mail, the phone will play a warning tone and the MESSAGE key LED will illuminate. The LCD screen will display a prompt message and flashing icon.

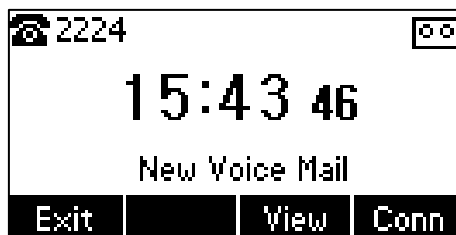

Note Voice mail is not available on all servers. Contact your system administrator for more information.

To leave a voice mail:

You can leave a voice mail for someone else when he/she is busy or inconvenient to answer the call. Follow the voice prompt from the system server to leave a voice mail, and then hang up.

To configure voice mail access codes via phone user interface:

1. Press **Menu->Messages->Voice Mail->Set Voice Mail**.

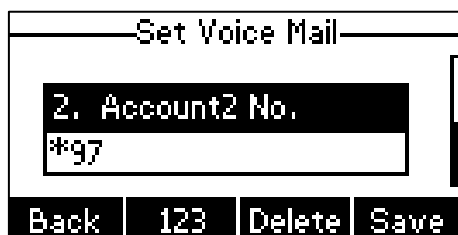

2. Press \uparrow or \downarrow to select the account which you want to set, press the **123** soft key to select the proper input mode and then enter the voice mail access code.
3. Press the **Save** soft key to accept the change or the **Back** soft key to cancel.

Note

Voice mail access code must be predefined on the system server. Contact your system administrator for the more information.

To listen to voice mails:

1. When the phone user interface prompts receiving new voice mails, press  or the **Conn** soft key to dial out the voice mail access code.
2. Follow the voice prompt to listen to voice mails.

Note

Before listening to voice mails, make sure the voice mail access code has been configured.

When all new voice mails are retrieved, the MESSAGE key LED will go out.

To view voice mails via phone user interface:

1. Press **Menu->Messages->Voice Mail->View Voice Mail**.

The LCD screen displays the amount of new and old voice mails.

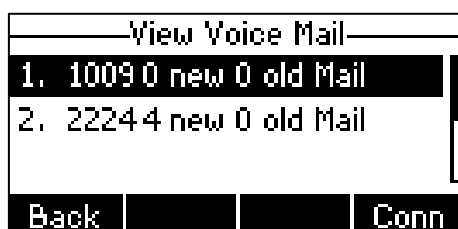

2. Select an account and then press the **Conn** soft key to listen to voice mails.

Message Waiting Indicator (MWI)

The SIP-T21P/SIPT21 IP phone supports MWI when receiving a new voice message. If someone leaves you a voice mail, you will receive a message waiting indicator. MWI

will be indicated in three ways: a warning tone, a prompt message (including a voice mail icon) on the LCD screen, and the MESSAGE key LED illuminates solid green. This will be cleared when you retrieve all voice mails or delete them.

The MWI service is unsolicited for some servers, so the SIP-T21P/SIP-T21 IP phone only handles the MWI messages sent from the server. But for other servers, the MWI service is solicited, so the SIP-T21P/SIP-T21 IP phone must enable subscription for MWI.

Note

MWI service is not available on all servers. Contact your system administrator for more information.

The MWI Subscription parameters you need to know:

Option	Description
Subscribe for MWI	Enable or disable a subscription for MWI service.
MWI Subscription Period	Period of MWI subscription. The IP phone sends a refresh SUBSCRIBE request before initial SUBSCRIBE expiration.
Subscribe MWI to Voice Mail	Enable or disable a subscription to the voice mail number for MWI service. To use this feature, you should configure subscribe for MWI and the voice mail number in advance.

Note

Whether the phone sends SUBSCRIBE messages for MWI service to the account or the voice mail number depends on the server. Contact your system administrator for more information.

To configure subscribe for MWI via web user interface:

1. Click on **Account**.
2. Select the desired account from the pull-down list of **Account**.
3. Click on **Advanced**.
4. Select **Enabled** from the pull-down list of **Subscribe for MWI** field.

- Enter the period time in the **MWI Subscription Period (Seconds)** field.

The screenshot shows the Yealink T21 web interface. The 'Account' tab is active, and the 'Advanced' sub-tab is selected. The 'Subscribe MWI To Voice Mail' field is currently set to 'Disabled'. Other fields include 'Subscribe Period (Seconds)' set to 1800, 'Voice Mail' set to an empty field, and 'MWI Subscription Period(Seconds)' set to 3600.

Field	Value
Account	Account 1
Keep Alive Type	Default
Keep Alive Interval	30
Local SIP Port	5062
RPort	Disabled
SIP Session Timer T1 (0.5~10s)	0.5
SIP Session Timer T2 (2~40s)	4
SIP Session Timer T4 (2.5~60s)	5
Subscribe Period (Seconds)	1800
DTMF Type	RFC2833
DTMF Info Type	DTMF-Relay
DTMF Payload Type(96~255)	101
Retransmission	Disabled
Subscribe for MWI	Enabled
MWI Subscription Period(Seconds)	3600
Subscribe MWI To Voice Mail	Disabled
Voice Mail	
CID Source	FROM

- Click **Confirm** to accept the change.

The IP phone will subscribe to the account number for MWI service by default.

To enable Subscribe MWI to Voice Mail via web user interface:

- Click on **Account**.
- Select the desired account from the pull-down list of **Account**.
- Click on **Advanced**.
- Select **Enabled** from the pull-down list of **Subscribe MWI To Voice Mail**.
- Enter the desired voice mail number in the **Voice Mail** field.

The screenshot shows the Yealink T21 web interface. The 'Account' tab is active, and the 'Advanced' sub-tab is selected. The 'Subscribe MWI To Voice Mail' field is now set to 'Enabled'. The 'Voice Mail' field is now set to '123'. Other fields remain the same as in the previous screenshot.

Field	Value
Account	Account 1
Keep Alive Type	Default
Keep Alive Interval	30
Local SIP Port	5062
RPort	Disabled
SIP Session Timer T1 (0.5~10s)	0.5
SIP Session Timer T2 (2~40s)	4
SIP Session Timer T4 (2.5~60s)	5
Subscribe Period (Seconds)	1800
DTMF Type	RFC2833
DTMF Info Type	DTMF-Relay
DTMF Payload Type(96~255)	101
Retransmission	Disabled
Subscribe for MWI	Enabled
MWI Subscription Period(Seconds)	3600
Subscribe MWI To Voice Mail	Enabled
Voice Mail	123
CID Source	FROM

6. Click **Confirm** to accept the change.

The IP phone will subscribe to the voice mail number for MWI service using
Subscribe MWI to Voice Mail.

Note

MWI subscription is configurable via web user interface only.

Troubleshooting

This chapter provides general troubleshooting information to help to solve the problems you might encounter when using your SIP-T21P/SIP-T21 IP phone.

If you require additional information or assistance with your new phone, contact your system administrator.

Why is the LCD screen blank?

- Ensure that the phone is properly plugged into a functional AC outlet.
- Ensure that the phone is plugged into a socket controlled by a switch that is on.
- If the phone is plugged into a power strip, try plugging it directly into a wall outlet instead.
- If your SIP-T21P IP phone is powered from PoE, ensure you use a PoE-compliant switch or hub.

Why does the phone display “Network Unavailable”?

- Ensure that the Ethernet cable is plugged into the Internet port on the phone and the Ethernet cable is not loose.
- Ensure that the switch or hub in your network is operational.
- Contact your system administrator for more information.

Why does the phone display “No Service”?

The LCD screen displays “No Service” when no SIP account registers successfully.

Why doesn't the phone display time and date correctly?

Check if you have configured the phone to obtain the time and date from the SNTP server automatically. If the phone fails to connect the SNTP server, configure the time and date manually.

How do I find the basic information of the phone?

Press the **OK** key when the phone is idle to check the basic information of the phone, such as the IP address and firmware version. For more the basic information, refer to [Phone Status](#) on page 13.

How to obtain the MAC address of a phone when the phone is not powered on?

Three ways you can obtain the MAC address of a phone:

- You can ask your supplier for shipping information sheet which includes MAC addresses according to the corresponding PO (Purchase Order).
- You can find the MAC address in the label of carton box.
- You can find the MAC address from the phone's bar code on the back of the phone.

Why can't I get a dial tone?

- Check for any loose connections and that the phone has been installed properly. For the installation instructions, refer to [Phone Installation](#) on page 11.
- Switch between the Handset, Headset (if present) and Hands-Free Speakerphone to check whether the dial tone is present for one of the audio modes.

If the dial tone exists on another audio mode, connect a different handset or headset to isolate the problem.

Why doesn't the phone ring?

Check that the ringer volume on the phone. To adjust the ringer volume setting, press the **Volume** key when the phone is idle. For more information, refer to [Volume](#) on page 24.

Why can't I receive calls?

- Check that the SIP registration with your system administrator.
- Check that DND (Do Not Disturb) feature is disabled on the phone. Refer to [Do Not Disturb \(DND\)](#) on page 73.
- Check that call forward is disabled on the phone. Refer to [Call Forward](#) on page 76.
- Check whether the caller number is stored in the blacklist. Refer to [Blacklist](#) on page 38.

Why is my handset not working?

Check that the handset cord is fully connected to both the handset jack on the phone and handset. Refer to [Phone Installation](#) on page 11.

Why is my headset not working?

- Check that the headset cord is fully connected to the headset jack on the phone. Refer to [Phone Installation](#) on page 11.
- Check that the headset mode is activated. Refer to [Headset Mode Activation/Deactivation](#) on page 45.

- Check that the headset volume is adjusted to an appropriate level. Refer to [Volume](#) on page 24.

What is the difference between user name, register name and display name?

Both user name and register name are defined by the server. A user name is used to identify the account while a register name matched with a password is used for authentication if the server requires. Display name is the caller ID that will be displayed on the callee’s LCD screen. Server configurations may override local configurations.

Why does the phone play a tone when there is a call on hold? How to disable it?

When there is a call on hold, the phone will play a hold tone every 30 seconds. Play hold tone is enabled by default. Play hold tone and play hold tone delay are configurable via web user interface only.

To configure play hold tone and play hold tone delay via web user interface:

1. Click on **Features->General Information**.
2. Select the desired value from the pull-down list of **Play Hold Tone**.
3. Enter the desired time (in seconds) in the **Play Hold Tone Delay** field.

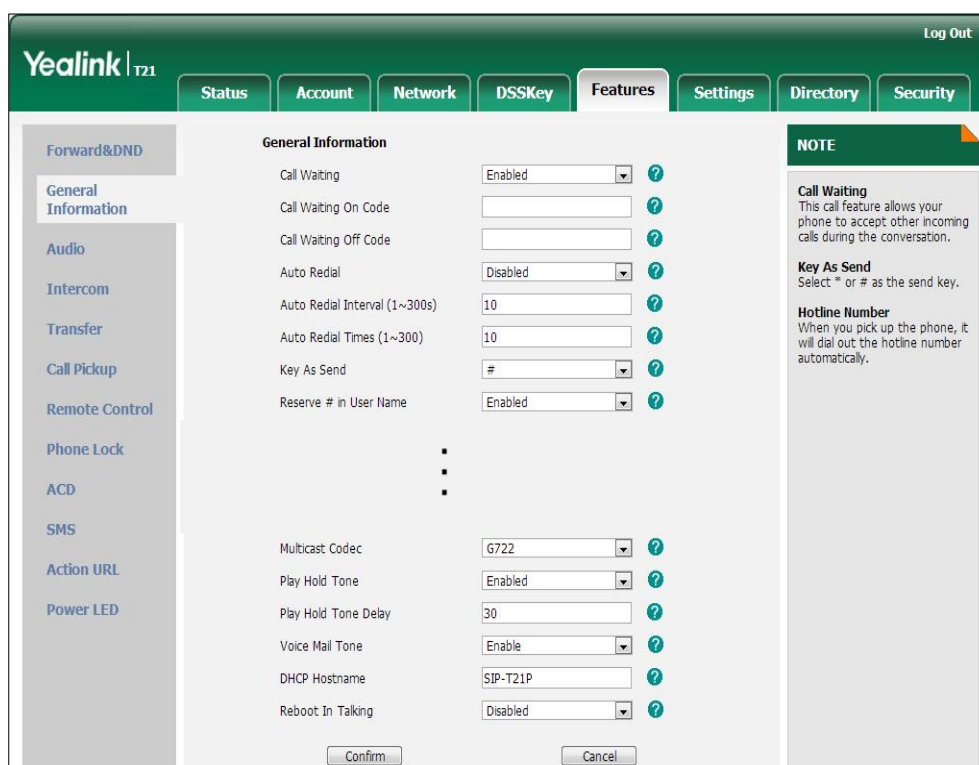

4. Click **Confirm** to accept the change.

Why can't I send a SMS to any other phone?

SMS depends on support from a SIP server. Contact your system administrator for more information.

How to change the user password?

To change the user password via web user interface:

1. Click on **Security->Password**.
2. Select **user** from the pull-down list of **User Type**.
3. Enter the new user password in the **New Password** field and **Confirm Password** field.

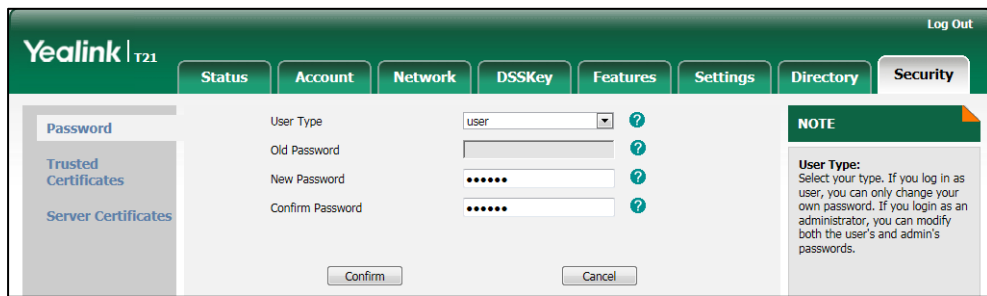

4. Click **Confirm** to accept the change.

Note

If logging into the web user interface of the phone with the user credential, you need to enter the current user password in the **Old Password** field.

User password is configurable via web user interface only.

How to make a call using SRTP?

You can enable SRTP to encrypt the audio stream(s) of phone calls. The parties participating in the call should enable SRTP. You can enable SRTP on a per-line basis.

To enable SRTP via web user interface:

1. Click on **Account**.
2. Select the desired account from the pull-down list of **Account**.
3. Click on **Advanced**.

- Select the desired value from the pull-down list of **RTP Encryption (SRTP)**.

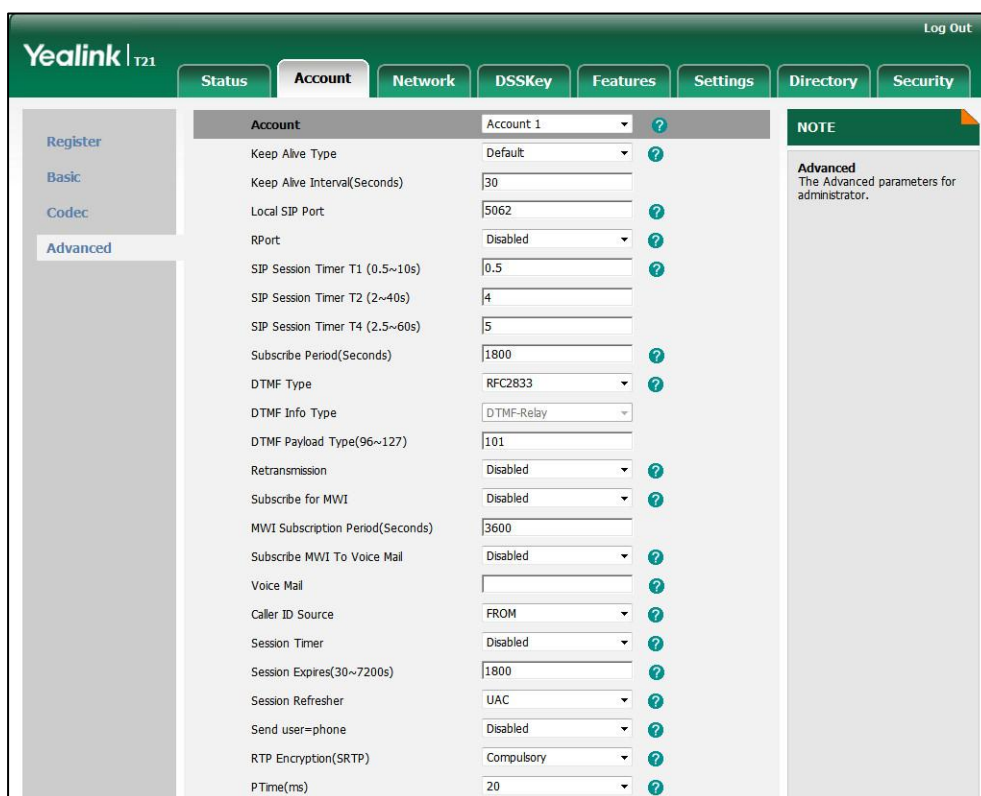

- Click **Confirm** to accept the change.

Note

SRTP is not available on all servers. Contact your system administrator for more information.

SRTP is configurable via web user interface only.

How to reboot the phone?

To reboot the phone via web user interface:

- Click on **Settings->Upgrade**.

2. Click **Reboot** to reboot the phone.

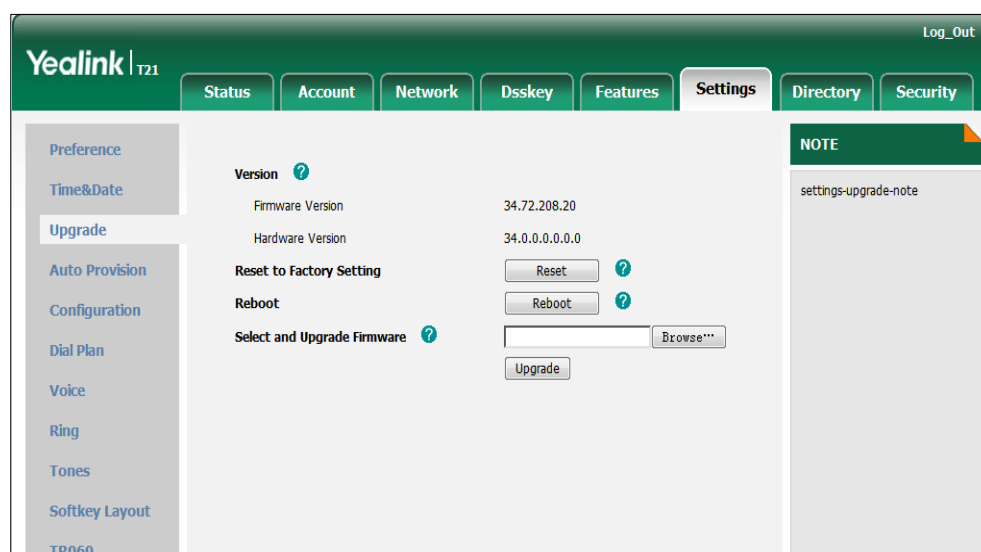

Note You can also long press the **X** key to reboot the phone directly. Any reboot of the phone may take a few minutes.

How to export PCAP trace?

We may need you to provide a PCAP trace to help analyze your problem.

To export a PCAP trace via web user interface:

1. Click on **Settings->Configuration**.
2. Click **Start** to start recording signal traffic.
3. Recreate the error to be documented in the trace.
4. Click **Stop** to stop recording.

5. Click **Export** to open file download window, and then save the file to your local system.

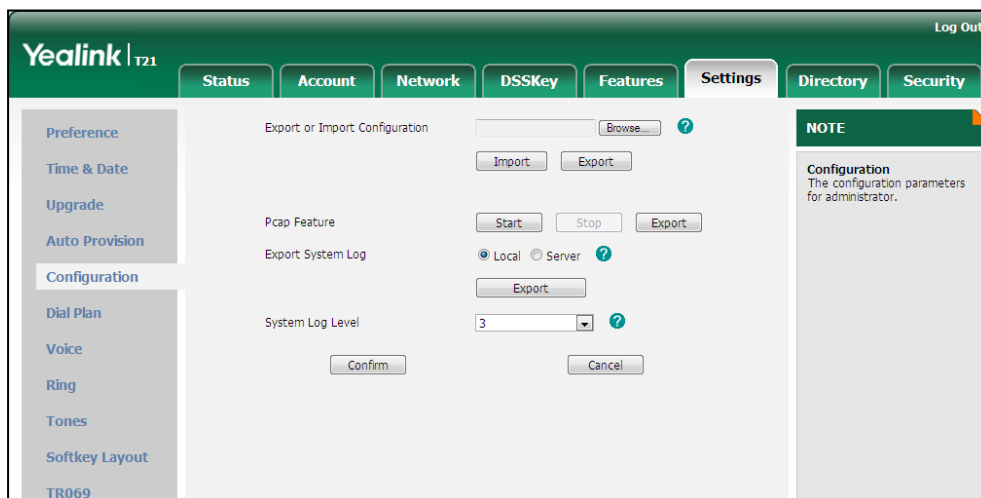

How to export system log?

We may need you to provide debug log information to help analyze problem. By default, you can export the debug system log information to local PC.

To export the system log to local PC via web user interface:

1. Click on **Settings->Configuration**.
2. Select **6** from the pull-down list of **System Log Level**.
The default system log level is 3.
3. Click **Confirm** to accept the change.
The web user interface prompts "Do you want to restart your machine?". The configuration will take effect after reboot.
4. Click **OK** to reboot the phone.
After the IP phone finishes reboot, the system log level is set as 6, the debug level.

5. Mark the **Local** radio box in the **Export System Log** field.

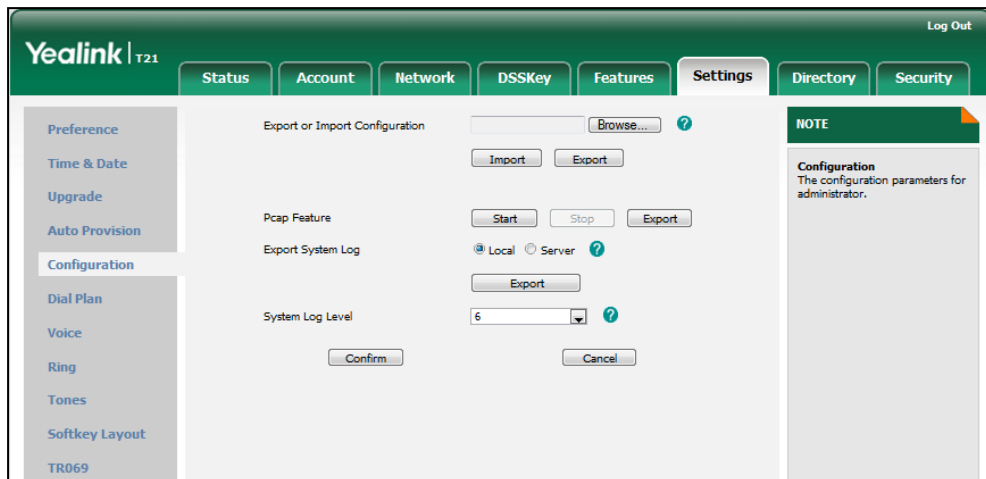

6. Click **Export** to open file download window, and then save the file to your local system.

You can also export the system log to a syslog server. Contact your system administrator for more information.

Note

It is recommended you reset the system log level to 3 after you have the syslog file provided.

How to export/import phone configurations?

We may need you to provide the phone configurations to help analyze your problem. In some instance, you may need to import configurations to the phone.

To export the phone configurations via web user interface:

1. Click on **Settings->Configuration**.
2. Click **Export** to open file download window, and then save the file to your local system.

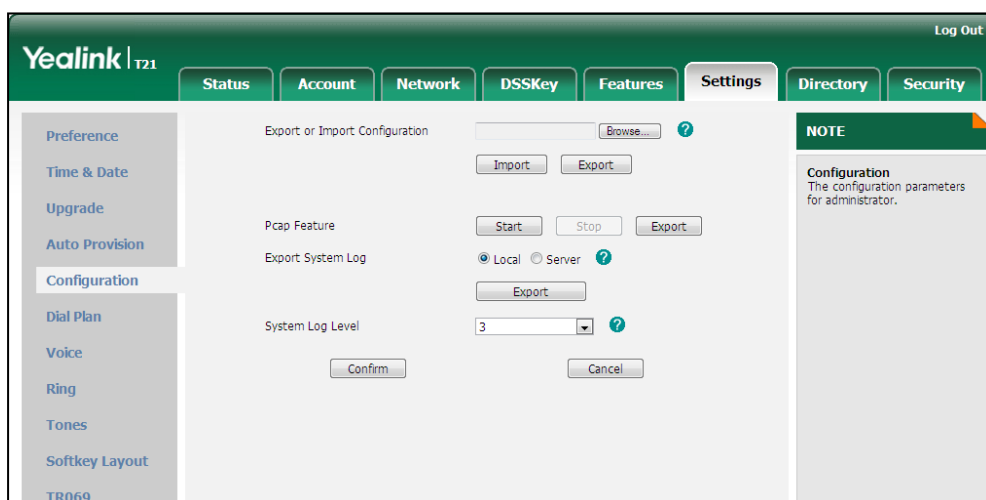

To import the phone configurations via web user interface:

1. Click on **Settings->Configuration**.
2. Click **Browse** to locate a configuration file from your local system.

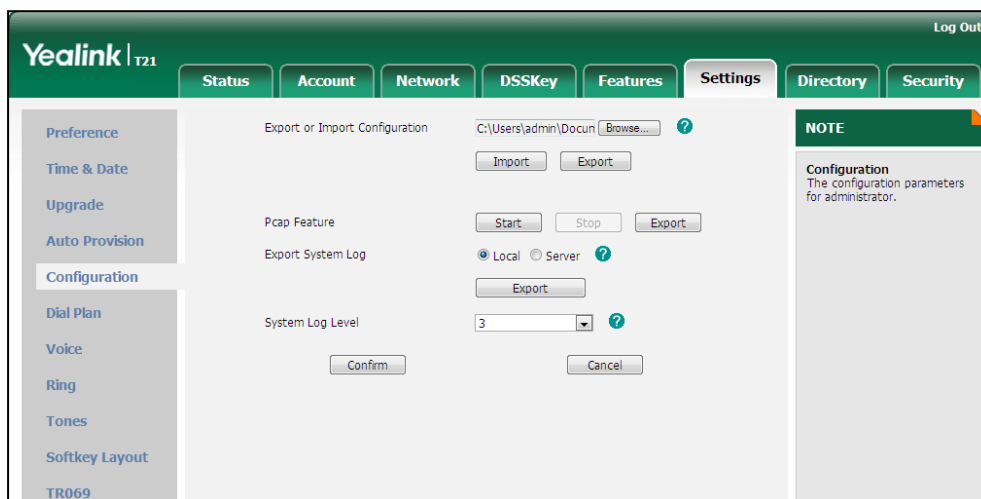

3. Click **Import** to import the configuration file.

Note The file format of configuration file must be *.bin.

How to upgrade firmware?

To upgrade firmware via web user interface:

1. Click on **Settings->Upgrade**.
2. Click **Browse** to locate the firmware from your local system.

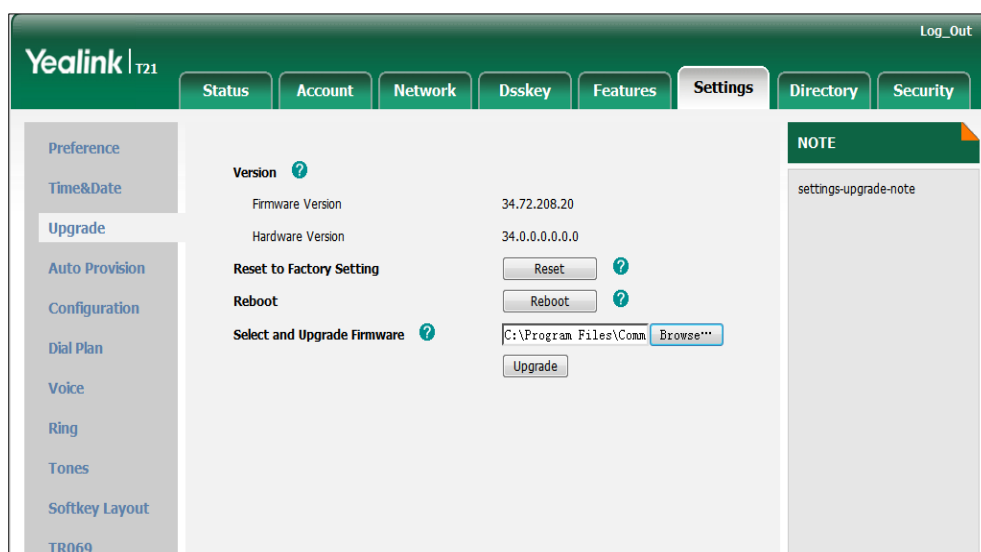

3. Click **Upgrade** to upgrade the firmware.

The web user interface prompts "Firmware of the SIP Phone will be updated. It will



take 5 minutes to complete. Please don't power off!"

4. Click **OK** to confirm upgrading.

How to reset the phone?

Reset the phone when other troubleshooting suggestions do not correct the problem. You need to note that all customized settings will be overwritten after resetting. We recommend asking your system administrator for advice before resetting the phone.

To reset the phone via phone user interface:

1. Press **Menu->Settings->Advanced Settings** (password: admin).
2. Press  or  to scroll to **Reset to Factory**, and then press the **Enter** soft key. The LCD screen prompts "Reset to factory settings?".

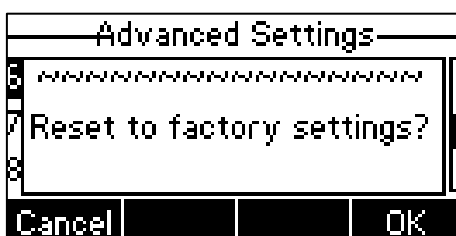

3. Press the **OK** soft key.

The LCD screen prompts "Resetting...Please Wait!".

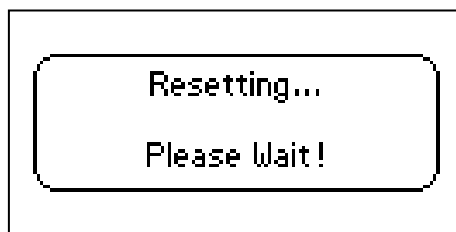

The LCD screen prompts "Welcom Initializing...please wait".

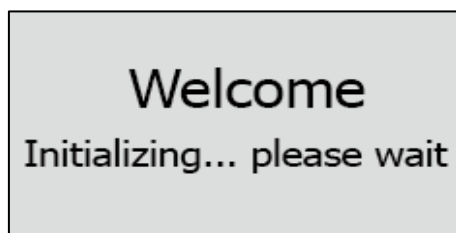

The phone will be reset to factory sucessfully after startup.

Note

Reset of your phone may take a few minutes. Do not power off until the phone starts up successfully.

Regulatory Notices

Service Agreements

Contact your Yealink Authorized Reseller for information about service agreements applicable to your product.

Limitations of Liability

TO THE FULL EXTENT ALLOWED BY LAW, YEALINK EXCLUDES FOR ITSELF AND ITS SUPPLIERS ANY LIABILITY, WHETHER BASED IN CONTRACT OR TORT (INCLUDING NEGLIGENCE), FOR INCIDENTAL, CONSEQUENTIAL, INDIRECT, SPECIAL, OR PUNITIVE DAMAGES OF ANY KIND, OR FOR LOSS OF REVENUE OR PROFITS, LOSS OF BUSINESS, LOSS OF INFORMATION OR DATA, OR OTHER FINANCIAL LOSS ARISING OUT OF OR IN CONNECTION WITH THE SALE, INSTALLATION, MAINTENANCE, USE, PERFORMANCE, FAILURE, OR INTERRUPTION OF ITS PRODUCTS, EVEN IF YEALINK OR ITS AUTHORIZED RESELLER HAS BEEN ADVISED OF THE POSSIBILITY OF SUCH DAMAGES, AND LIMITS ITS LIABILITY TO REPAIR, REPLACEMENT, OR REFUND OF THE PURCHASE PRICE PAID, AT YEALINK'S OPTION. THIS DISCLAIMER OF LIABILITY FOR DAMAGES WILL NOT BE AFFECTED IF ANY REMEDY PROVIDED HEREIN SHALL FAIL OF ITS ESSENTIAL PURPOSE.

Safety Instructions

Save these instructions. Read these safety instructions before use!

The following basic safety precautions should always be followed to reduce risk of fire, electrical shock, and other personal injury.

General Requirements

- Before you install and use the device, read the safety instructions carefully and observe the situation during operation.
- During the process of storage, transportation, and operation, please always keep the device dry and clean.
- During the process of storage, transportation, and operation, please avoid collision and crash of the device.
- Please attempt not to dismantle the device by yourself. In case of any discrepancy, please contact the appointed maintenance center for repair.
- Without prior written consent, no organization or individual is permitted to make any change to the structure or the safety design of the device. Yealink is under no circumstance liable to consequences or legal issues caused by such changes.
- Please refer to the relevant laws and statutes while using the device. Legal rights of others should be respected as well.

Environmental Requirements

- Place the device at a well-ventilated place. Do not expose the device under direct sunlight.
- Keep the device dry and free of dusts.
- Place the device on a stable and level platform.

- Please place no heavy objects on the device in case of damage and deformation caused by the heavy load.
- Keep at least 10 cm between the device and the closest object for heat dissipation.
- Do not place the device on or near any inflammable or fire-vulnerable object, such as rubber-made materials.
- Keep the device away from any heat source or bare fire, such as a candle or an electric heater.
- Keep the device away from any household appliance with strong magnetic field or electromagnetic field, such as a microwave oven or a refrigerator.

Operating Requirements

- Do not let a child operate the device without guidance.
- Do not let a child play with the device or any accessory in case of accidental swallowing.
- Please use the accessories provided or authorized by the manufacturer only.
- The power supply of the device shall meet the requirements of the input voltage of the device. Please use the provided surge protection power socket only.
- Before plugging or unplugging any cable, make sure that your hands are completely dry.
- Do not spill liquid of any kind on the product or use the equipment near water, for example, near a bathtub, washbowl, kitchen sink, wet basement or near a swimming pool.
- Do not tread on, pull, or over-bend any cable in case of malfunction of the device.
- During a thunderstorm, stop using the device and disconnect it from the power supply. Unplug the power plug and the Asymmetric Digital Subscriber Line (ADSL) twisted pair (the radio frequency cable) to avoid lightning strike.
- If the device is left unused for a rather long time, disconnect it from the power supply and unplug the power plug.
- When there is smoke emitted from the device, or some abnormal noise or smell, disconnect the device from the power supply, and unplug the power plug immediately. Contact the specified maintenance center for repair.
- Do not insert any object into equipment slots that is not part of the product or auxiliary product.
- Before connecting a cable, connect the grounding cable of the device first. Do not disconnect the grounding cable until you disconnect all other cables.

Cleaning Requirements

- Before cleaning the device, stop using it and disconnect it from the power supply.
- Use a piece of soft, dry and anti-static cloth to clean the device.
- Keep the power plug clean and dry. Using a dirty or wet power plug may lead to electric shock or other perils.

Appendix A - Time Zones

Time Zone	Time Zone Name
- 11:00	Samoa
- 10:00	United States-Hawaii-Aleutian
- 10:00	United States-Alaska-Aleutian
- 09:00	United States-Alaska Time
- 08:00	Canada(Vancouver, Whitehorse)
- 08:00	Mexico(Tijuana, Mexicali)
- 08:00	United States-Pacific Time
- 07:00	Canada(Edmonton, Calgary)
- 07:00	Mexico(Mazatlan, Chihuahua)
- 07:00	United States-Mountain Time
- 07:00	United States-MST no DST
- 06:00	Canada-Manitoba(Winnipeg)
- 06:00	Chile(Easter Islands)
- 06:00	Mexico(Mexico City, Acapulco)
- 06:00	United States-Central Time
- 05:00	Bahamas(Nassau)
- 05:00	Canada(Montreal, Ottawa, Quebec)
- 05:00	Cuba(Havana)
- 05:00	United States-Eastern Time
- 04:30	Venezuela(Caracas)
- 04:00	Canada(Halifax, Saint John)
- 04:00	Chile(Santiago)
- 04:00	Paraguay(Asuncion)
- 04:00	United Kingdom-Bermuda(Bermuda)
- 04:00	United Kingdom(Falkland Islands)
- 04:00	Trinidad&Tobago
- 03:30	Canada-New Foundland(St.Johns)
- 03:00	Denmark-Greenland(Nuuk)
- 03:00	Argentina(Buenos Aires)
- 03:00	Brazil(no DST)
- 03:00	Brazil(DST)
- 02:00	Brazil(no DST)
- 01:00	Portugal(Azores)
0	GMT
0	Greenland
0	Denmark-Faroe Islands(Torshavn)
0	Ireland(Dublin)
0	Portugal(Lisboa, Porto, Funchal)
0	Spain-Canary Islands(Las Palmas)
0	United Kingdom(London)
0	Morocco
+ 01:00	Albania(Tirane)
+ 01:00	Austria(Vienna)
+ 01:00	Belgium(Brussels)
+ 01:00	Caicos
+ 01:00	Chad
+ 01:00	Croatia(Zagreb)
+ 01:00	Czech Republic(Prague)
+ 01:00	Denmark(Kopenhagen)
+ 01:00	France(Paris)
+ 01:00	Germany(Berlin)

Time Zone	Time Zone Name
+01:00	Hungary(Budapest)
+01:00	Italy(Rome)
+01:00	Luxembourg(Luxembourg)
+01:00	Macedonia(Skopje)
+01:00	Netherlands(Amsterdam)
+01:00	Namibia(Windhoek)
+02:00	Estonia(Tallinn)
+02:00	Finland(Helsinki)
+02:00	Gaza Strip(Gaza)
+02:00	Greece(Athens)
+02:00	Israel(Tel Aviv)
+02:00	Jordan(Amman)
+02:00	Latvia(Riga)
+02:00	Lebanon(Beirut)
+02:00	Moldova(Kishinev)
+02:00	Russia(Kaliningrad)
+02:00	Romania(Bucharest)
+02:00	Syria(Damascus)
+02:00	Turkey(Ankara)
+02:00	Ukraine(Kyiv, Odessa)
+03:00	East Africa Time
+03:00	Iraq(Baghdad)
+03:00	Russia(Moscow)
+03:30	Iran(Teheran)
+04:00	Armenia(Yerevan)
+04:00	Azerbaijan(Baku)
+04:00	Georgia(Tbilisi)
+04:00	Kazakhstan(Aktau)
+04:00	Russia(Samara)
+04:30	Afghanistan
+05:00	Kazakhstan(Aqtobe)
+05:00	Kyrgyzstan(Bishkek)
+05:00	Pakistan(Islamabad)
+05:00	Russia(Chelyabinsk)
+05:30	India(Calcutta)
+06:00	Kazakhstan(Astana, Almaty)
+06:00	Russia(Novosibirsk, Omsk)
+07:00	Russia(Krasnoyarsk)
+07:00	Thailand(Bangkok)
+08:00	China(Beijing)
+08:00	Singapore(Singapore)
+08:00	Australia(Perth)
+09:00	Korea(Seoul)
+09:00	Japan(Tokyo)
+09:30	Australia(Adelaide)
+09:30	Australia(Darwin)
+10:00	Australia(Sydney, Melbourne, Canberra)
+10:00	Australia(Brisbane)
+10:00	Australia(Hobart)
+10:00	Russia(Vladivostok)
+10:30	Australia(Lord Howe Islands)
+11:00	New Caledonia(Noumea)
+12:00	New Zealand(Wellington, Auckland)
+12:45	New Zealand(Chatham Islands)
+13:00	Tonga(Nukualofa)

Index

A

About This Guide [v](#)
 Account Management [54](#)
 Account Registration [54](#)
 Adding Contacts [31](#)
 Adding Groups [29](#)
 Administrator password [20](#)
 Anonymous Call [93](#)
 Anonymous Call Rejection [94](#)
 Answering Calls [65](#)
 Area Code [58](#)
 Attaching Stand [11](#)
 Audio Settings [24](#)
 Auto Answer [68](#)
 Auto Redial [69](#)
 Automatic Call Distribution (ACD) [107](#)

B

Basic Network Settings [14](#)
 Blacklist [38](#)
 Block Out [59](#)
 Busy Lamp Field (BLF) [95](#)

C

Call Completion [70](#)
 Call Forward [76](#)
 Call History Management [42](#)
 Call Hold/Resume [72](#)
 Call Mute [71](#)
 Call Park [87](#)
 Call Pickup [88](#)
 Call Recording [97](#)
 Call Return [71](#)
 Call Transfer [82](#)
 Call Waiting [84](#)
 CE Mark Warning [ii](#)
 Conference [84](#)
 Contact Management [27](#)
 Contrast [17](#)
 Copyright [ii](#)
 Customizing Your Phone [17](#)

D

Declaration of Conformity [ii](#)
 Deleting Contacts [33](#)
 Deleting Groups [30](#)
 Dial-now [57](#)
 Dial Plan [55](#)
 Directory [27](#)

Do Not Disturb (DND) [73](#)
 Documentations [8](#)
 DSS Keys [46](#)

E

Editing Contacts [33](#)
 Editing Groups [29](#)
 Emergency Number [60](#)
 Ending Calls [66](#)

G

General Settings [17](#)
 Getting Started [9](#)

H

Hardware Component Instructions [1](#)
 Headset Mode Activation/Deactivation [45](#)
 Headset Prior [45](#)
 Headset Use [45](#)
 Hot Desking [99](#)
 Hotline [62](#)

I

Icon Instructions [3](#)
 Idle screen [16](#)
 Importing/Exporting Contact lists [37](#)
 In This Guide [v](#)
 Incoming Intercom Calls [101](#)
 Intercom [101](#)

K

Key as Send [21](#)
 Keypad Lock [21](#)

L

Language [18](#)
 LED Instructions [4](#)
 Limitation of Liability [127](#)
 Line Keys [46](#)
 Live Dialpad [61](#)
 Local Conference [85](#)
 Local Directory [28](#)
 Logo Customization [44](#)

M

Messages [109](#)

Message Waiting Indicator 112
Multicast Paging 103
Music on Hold 106

Warranty ii
Web User Interface 5
WEEE Warning iii

N

Network Conference 85
Network Connection 11
No answer Forward 76

O

Outgoing Intercom Calls 101
Overview 1

P

Packaging Contents 9
Phone Initialization 13
Phone Installation 11
Phone Status 13
Phone User Interface 5
Placing Calls 63
Placing Calls to Contacts 34
Programmable Keys 53

R

Receiving RTP Stream 105
Recent Call In Dialing 67
Redialing Numbers 67
Registration 16
Regulatory Notices 127
Remote Phone Book 40
Replace Rule 55
Ring Tones 25

S

Safety Instructions 127
Search Source List in Dialing 35
Searching for Contacts 35
Semi-attended Transfer 82
Sending RTP Stream 103
Service Agreements 127
Short Message Service (SMS) 109
System Customizations 44

T

Time and Date 19
Time Zones 129
Troubleshooting 117

V

Voice Mail 111
Volume 24

W